

Aspire one Series Service Guide

Service guide files and updates are available on the ACER/CSD web; for more information, please refer to <http://csd.acer.com.tw>

PRINTED IN TAIWAN

Revision History

Please refer to the table below for the updates made on Aspire one Series service guide.

Date	Chapter	Updates

Copyright

Copyright © 2008 by Acer Incorporated. All rights reserved. No part of this publication may be reproduced, transmitted, transcribed, stored in a retrieval system, or translated into any language or computer language, in any form or by any means, electronic, mechanical, magnetic, optical, chemical, manual or otherwise, without the prior written permission of Acer Incorporated.

Disclaimer

The information in this guide is subject to change without notice.

Acer Incorporated makes no representations or warranties, either expressed or implied, with respect to the contents hereof and specifically disclaims any warranties of merchantability or fitness for any particular purpose. Any Acer Incorporated software described in this manual is sold or licensed "as is". Should the programs prove defective following their purchase, the buyer (and not Acer Incorporated, its distributor, or its dealer) assumes the entire cost of all necessary servicing, repair, and any incidental or consequential damages resulting from any defect in the software.

Acer is a registered trademark of Acer Corporation.

Intel is a registered trademark of Intel Corporation.

Pentium and Pentium II/III are trademarks of Intel Corporation.

Other brand and product names are trademarks and/or registered trademarks of their respective holders.

Conventions

The following conventions are used in this manual:

SCREEN MESSAGES	Denotes actual messages that appear on screen.
NOTE	Gives bits and pieces of additional information related to the current topic.
WARNING	Alerts you to any damage that might result from doing or not doing specific actions.
CAUTION	Gives precautionary measures to avoid possible hardware or software problems.
IMPORTANT	Reminds you to do specific actions relevant to the accomplishment of procedures.

Preface

Before using this information and the product it supports, please read the following general information.

1. This Service Guide provides you with all technical information relating to the BASIC CONFIGURATION decided for Acer's "global" product offering. To better fit local market requirements and enhance product competitiveness, your regional office MAY have decided to extend the functionality of a machine (e.g. add-on card, modem, or extra memory capability). These LOCALIZED FEATURES will NOT be covered in this generic service guide. In such cases, please contact your regional offices or the responsible personnel/channel to provide you with further technical details.
2. Please note WHEN ORDERING FRU PARTS, that you should check the most up-to-date information available on your regional web or channel. If, for whatever reason, a part number change is made, it will not be noted in the printed Service Guide. For ACER-AUTHORIZED SERVICE PROVIDERS, your Acer office may have a DIFFERENT part number code to those given in the FRU list of this printed Service Guide. You MUST use the list provided by your regional Acer office to order FRU parts for repair and service of customer machines.

System Specifications	1
Features	1
System Block Diagram	3
Your Acer Notebook tour	4
Front View	4
Closed Front View	5
Left View	5
Right View	6
Rear View	6
Bottom View	7
Indicators	7
TouchPad Basics	8
Using the Keyboard	9
Lock Keys and embedded numeric keypad	9
Hot Keys	10
Special Key	11
Hardware Specifications and Configurations	12
 System Utilities	 19
BIOS Setup Utility	19
Navigating the BIOS Utility	19
Information	20
Main	21
Security	22
Boot	25
Exit	26
BIOS Flash Utility	27
Remove HDD/BIOS Utility	29
 Machine Disassembly and Replacement	 33
Disassembly Requirements	33
Related Information	33
General Information	34
Pre-disassembly Instructions	34
Disassembly Process	34
External Module Disassembly Process	35
External Modules Disassembly Flowchart	35
Removing the Battery Pack	36
Removing the 3G Cover	37
Removing the Keyboard	38
Removing the Upper and Lower Covers	39
LCD Module Disassembly Process	41
LCD Module Disassembly Flowchart	41
Removing the LCD Module	42
Removing the LCD Bezel	44
Removing the Camera Board	45
Removing the MIC Board	46
Removing the LCD Panel	47
Removing the LCD Brackets and FPC Cable	48
Main Unit Disassembly Process	50
Main Unit Disassembly Flowchart	50
Removing the WLAN Module	51
Removing the USB/LED/Power/Card Reader Board	52
Removing the SSD Module	53

Table of Contents

Removing the Mainboard	55
Removing the Speaker Module	56
Removing the Hard Disk Drive Module	58
Removing the DIMM Module	60
Removing the Thermal Module	61
LCD Module Reassembly Procedure	63
Replacing the LCD Brackets and FPC Cable	63
Replacing the LCD Panel	64
Replacing the Mic Board	65
Replacing the Camera Board	65
Replacing the LCD Bezel	66
Main Module Reassembly Procedure	67
Replacing the Thermal Module	67
Replacing the DIMM Module	67
Replacing the Hard Disk Drive Module	68
Replacing the Speaker Module	68
Replacing the Mainboard	70
Replacing the SDD Module	71
Replacing the USB/LED/Power/Card Reader Board	72
Replacing the WLAN Board	73
Replacing the LCM Module	73
Replacing the Upper Cover	75
Replacing the Keyboard	76
Replacing the 3G cover	77
Replacing the Battery	77

Troubleshooting 79

Common Problems	79
Power On Issue	80
No Display Issue	81
Random Loss of BIOS Settings	83
LCD Failure	84
Built-In Keyboard Failure	84
TouchPad Failure	85
Internal Speaker Failure	85
Internal Microphone Failure	87
HDD Not Operating Correctly	88
USB Failure (Rightside)	89
Power Button Failure	89
External Mouse Failure	90
Other Failures	90
Intermittent Problems	91
Undetermined Problems	91
Frequently Asked Questions (FAQ)	92
POST Code Reference Tables	102
Sec:	102
Memory:	102
BDS & Specific action:	103
Each PEIM entry point used in 80_PORT	105
Each Driver entry point used in 80_PORT	105
Each SmmDriver entry point used in 80_PORT	108

Jumper and Connector Locations 111

Top View	111
Bottom View	112

Table of Contents

Clearing Password Check and BIOS Recovery	113
Clearing Password Check	113
BIOS Recovery by Crisis Disk	114
FRU (Field Replaceable Unit) List	115
Aspire one Exploded Diagram	116
Aspire one FRU List	118
Screw List	126
Model Definition and Configuration	128
Aspire one Series	128
Aspire one Blue	128
Aspire one White	142
Test Compatible Components	155
Linux Environment Test	156
Aspire one Blue Testing Information	156
Aspire one White Testing Information	158
Online Support Information	161
Index	163

Table of Contents

System Specifications

Features

Below is a brief summary of the computer's many feature:

Operating System

- Microsoft Windows® XP™ / Linux

Platform

- Diamondville Atom series standard voltage 533FSB processors
 - Intel 945GSE + ICH7M Chipset

System Memory

NOTE: It is not possible for end users to upgrade the Aspire one memory.

- One DDRII SO-DIMM slots support 512MB to 1024MB system memory
 - 512MB on board memory
 - 1MB Flash BIOS

Display and graphics

- 8.9" Wide Screen LCD (1024x600)
 - LED backlight LCD

Storage subsystem

- 8GB SSD module PATA interface
- Fixed type for 80GB or higher capacity SATA HDD

Audio

- HD audio codec
- Internal Digital MIC

Dimensions and Weight

- 248 (W) x 169.4 (D) x 29.5 (H) mm (ME dimension)
- 995g weight with 8.9" LCD and 8GB SSD

Communication

- On-Board PCI-E 10/100 LAN
- Mini-card Wireless LAN
- Wake-on-LAN support

-
- 3G module through USB

Privacy control

- BIOS user, supervisor, and power on passwords
- Kensington lock slot

Power subsystem

- 2-cell 2200mAh
- 6-cell 5200mAh
- 30W 19V 3-pin AC adapter

Special keys and controls

- New Acer Aspire one keyboard support
- Power button and Wireless LAN/3G switch

I/O interface

- 2 * Express card slot
- 1 * VGA port, 15 pins
- 1 * Microphone-in/Line-in
- 1 * Line-out / Headphone out
- 3 * External USB 2.0
- 1 * DC in jack
- 1 * RJ-45 jack for LAN
- 1 * Internal Digital MIC
- 1 * 5-in-1 card reader
- 1 * SD card reader

Environment

- Temperature:
 - Operating: 5 °C to 35 °C
 - Non-operating: -20 °C to 65 °C
- Humidity (non-condensing):
 - Operating: 20% to 80%
 - Non-operating: 20% to 80%

System Block Diagram

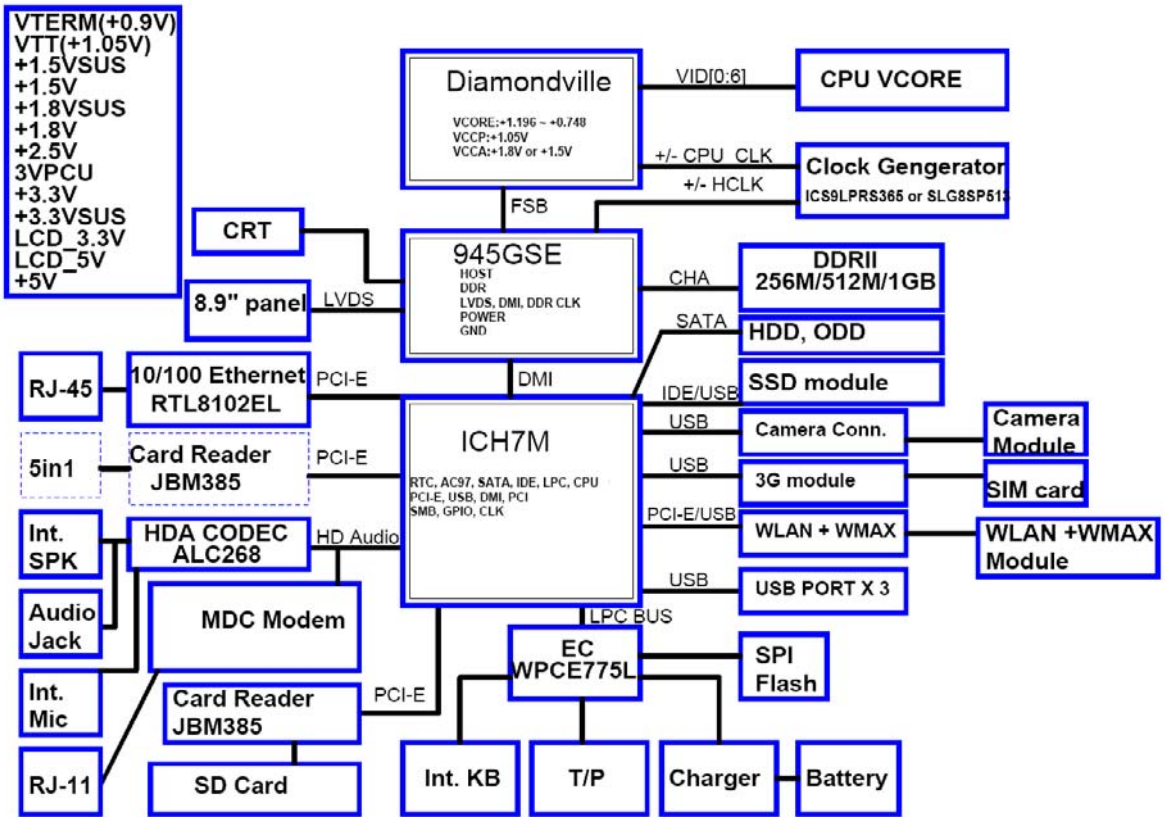



Your Acer Notebook tour

After knowing your computer features, let us show you around your new computer.

Front View



No.	Icon	Item	Description
1		Microphone	Internal microphone for sound recording.
2		Acer Crystal Eye Webcam	Web camera for video communication (only for certain models).
3		Power button	Turns the computer on and off.
4		Wireless LAN communication indicator	Indicates the status of wireless LAN communication.
5		Click buttons (left and right)	The left and right buttons function like the left and right mouse buttons.
6		TouchPad	Touch-sensitive pointing device which functions like a computer mouse.
7		Keyboard	For entering data into your computer.
8		Status indicators	Light-Emitting Diodes (LEDs) that light up to show the status of the computer's functions and components.
9		Display screen	Also called Liquid-Crystal Display (LCD), displays computer output.

Closed Front View



No.	Icon	Item	Description
1		Wireless communication switch	Enables/disables the wireless function.



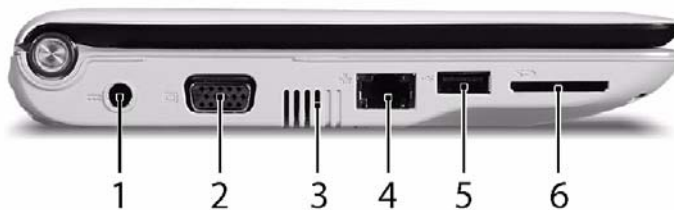

Left View

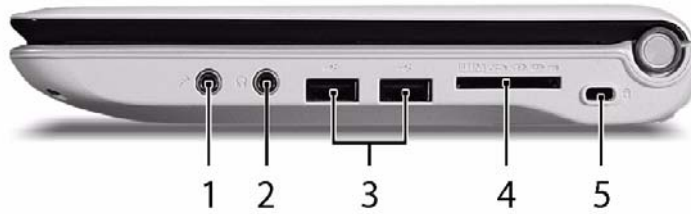

No.	Icon	Item	Description
1		DC-in jack	Connects to an AC adapter
2		External display (VGA) port	Connects to a display device (e.g. external monitor, LCD projector).
3		Ventilation slots and cooling fan	Enable the computer to stay cool, even after prolonged use. Note: Do not cover or obstruct the fan opening.
4		Ethernet (RJ-45) port	Connects to an Ethernet 10/100-based network.
5		USB 2.0 port	Connect to USB 2.0 devices (e.g. USB mouse).
6		Storage expansion slot	Accepts one Secure Digital (SD) card, used to expand the capacity of My Files . Push the card inwards and let it pop out before removing. Note: This slot is for expanding My Files long-term. For transferring files to and from other devices, use the 5-in-1 card reader.

Right View



No.	Icon	Item	Description
1		Microphone-in jack	Accepts input from external microphones.
2		Headphones/speaker/line-out jack	Connects to line-out audio devices (e.g. speakers, headphones).
3		USB 2.0 ports	Connect to USB 2.0 devices (e.g. USB mouse).
4		Multi-in-1 card reader	Accepts Secure Digital (SD), MultiMediaCard (MMC), Memory Stick (MS), Memory Stick PRO (MS PRO), xD-Picture Card (xD). Note: Push to remove/install the card. Only one card can operate at any given time.
5		Kensington lock slot	Connects to a Kensington-compatible computer security lock.

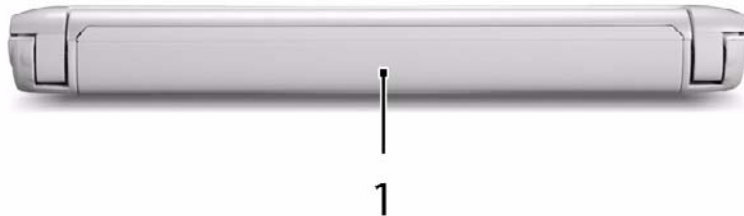

Rear View



No.	Icon	Item	Description
1		Battery bay	Houses the computer's battery pack.

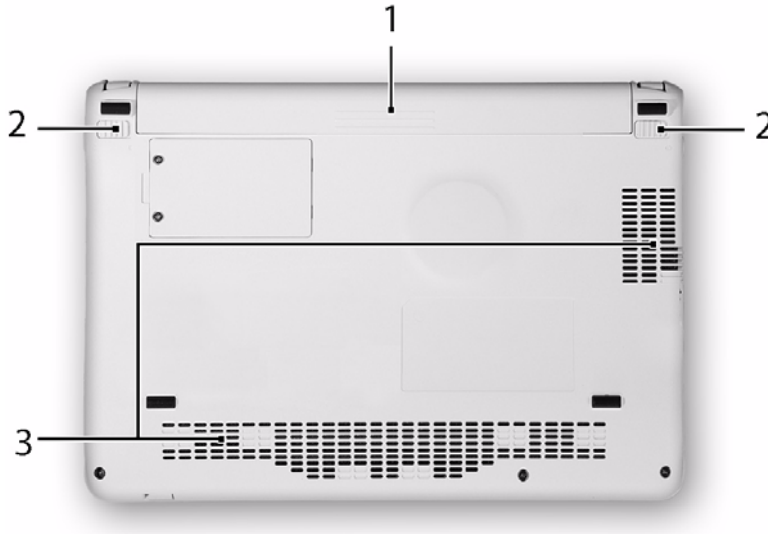



Bottom View



No.	Icon	Item	Description
1		Battery bay	Houses the computer's battery pack.
2		Battery lock	Locks the battery in position.
		Battery release latch	Releases the battery for removal.
3		Ventilation slots (right) and Speaker grill (bottom)	<ul style="list-style-type: none"> Vents enable the computer to stay cool, even after prolonged use. <p>Note: Do not cover or obstruct the cooling vents.</p> <ul style="list-style-type: none"> Speaker grills allow audio to pass through the casing unhindered.

Indicators

The computer has several easy-to-read status indicators. The front panel indicators are visible even when the computer cover is closed.

Icon	Function	Description
	Battery	Indicates the computer's battery status.
	HDD	Indicates when the hard disk drive is active.
	Num Lock	Lights up when Num Lock is activated.
	Caps Lock	Lights up when Caps Lock is activated.

NOTE: 1. **Charging:** The battery light shows amber when the battery is charging. 2. **Fully charged:** The light shows green when in AC mode.

TouchPad Basics

The following items show you how to use the TouchPad:

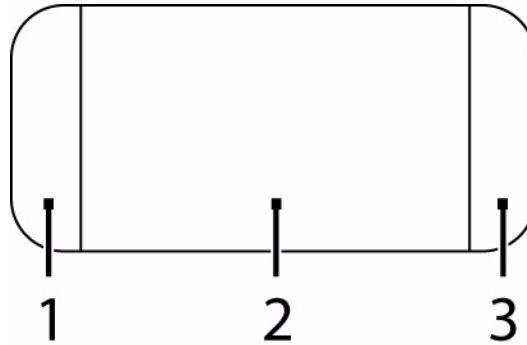

- Move your finger across the TouchPad (2) to move the cursor.
- Press the left (1) and right (3) buttons located beneath the TouchPad to perform selection and execution functions. These two buttons are similar to the left and right buttons on a mouse. Tapping on the TouchPad is the same as clicking the left button.

Function	Left Button (1)	Right Button (3)	Main TouchPad (2)
Execute	Quickly click twice.		Tap twice (at the same speed as double-clicking a mouse button).
Select	Click once.		Tap once.
Drag	Click and hold, then use finger on the TouchPad to drag the cursor.		Tap twice (at the same speed as double-clicking a mouse button); rest your finger on the TouchPad on the second tap and drag the cursor.
Access context menu		Click once.	

NOTE: When using the TouchPad, keep it - and your fingers - dry and clean. The TouchPad is sensitive to finger movement; hence, the lighter the touch, the better the response. Tapping too hard will not increase the TouchPad's responsiveness.

Using the Keyboard

Your Aspire one has a close-to-full-sized keyboard and an embedded numeric keypad, separate cursor, lock, function and special keys.

Lock Keys and embedded numeric keypad

The keyboard has three lock keys which you can toggle on and off.



Lock key	Description
Caps Lock	When Caps Lock is on, all alphabetic characters typed are in uppercase.
Num Lock <Fn> + <F11>	When Num Lock is on, the embedded keypad is in numeric mode. The keys function as a calculator (complete with the arithmetic operators +, -, *, and /). Use this mode when you need to do a lot of numeric data entry. A better solution would be to connect an external keypad.
Scroll Lock <Fn> + <F12>	When Scroll Lock is on, the screen moves one line up or down when you press the up or down arrow keys respectively. Scroll Lock does not work with some applications.

The embedded numeric keypad functions like a desktop numeric keypad. It is indicated by small characters located on the upper right corner of the keycaps. To simplify the keyboard legend, cursor-control key symbols are not printed on the keys.

Desired access	Num Lock on	Num Lock off
Number keys on embedded keypad	Type numbers in a normal manner.	
Main keyboard keys	Hold <Fn> while typing letters on embedded keypad.	Type the letters in a normal manner.

Hot Keys

The computer employs hotkeys or key combinations to access most of the computer's controls like screen brightness and volume output.

To activate hotkeys, press and hold the **<Fn>** key before pressing the other key in the hotkey combination.



Hotkey	Icon	Function	Description
<Fn> + <F4>		Sleep	Puts the computer in Sleep mode.
<Fn> + <F5>		Display toggle	Switches display output between the display screen, external monitor (if connected) and both.
<Fn> + <F6>		Screen blank	Turns the display screen backlight off to save power. Press any key to return.
<Fn> + <F7>		TouchPad toggle	Turns the internal TouchPad on and off.
<Fn> + <F8>		Speaker toggle	Turns the speakers on and off.
<Fn> + <▷>		Brightness up	Increases the screen brightness.
<Fn> + <◁>		Brightness down	Decreases the screen brightness.
<Fn> + <△>		Volume up	Increases the sound volume.
<Fn> + <▽>		Volume down	Decreases the sound volume.

Special Key

You can locate the Euro symbol and the US dollar sign at the upper-center and/or bottom-right of your keyboard.



The Euro symbol

1. Open a text editor or word processor.
2. Hold <Alt Gr> and then press the <5> key at the upper-center of the keyboard.

NOTE: Some fonts and software do not support the Euro symbol.

The US dollar sign

1. Open a text editor or word processor.
2. Hold <Shift> and then press the <4> key at the upper-center of the keyboard.

NOTE: This function varies according to the language settings.

Hardware Specifications and Configurations

Processor

Item	Specification
CPU type	Diamondville Atom series standard voltage 533FSB processors
CPU package	Diamondville 437-balls Micro-FCBGA8 package 22x22mm
Features	<ul style="list-style-type: none"> • New single-core processor for mobile devices with enhanced performance • On-die, primary 32-kB instructions cache and 24-kB write-back data cache • 100/133-MHz Source-Synchronous front side bus (FSB) • Supports Hyper-Threading Technology 2-threads • On-Die 512-kB, 8-way L2 cache • Support for IA 32-bit and Intel® 64 architecture • Streaming SIMD Extensions 2 and 3 (SSE2 and SSE3) support • Thermal management support via Intel Thermal Monitor 1 and Intel Thermal Monitor 2 • FSB Lane Reversal for flexible routing • Supports C0/C1(E)/C2(E)/C4(E) • L2 Dynamic Cache Sizing • Advanced power management features including Enhanced Intel SpeedStep® Technology • Execute Disable Bit support for enhanced security

System Controller

Item	Specification
Processor Support	<ul style="list-style-type: none"> • Intel Core 2 Duo mobile processor LV and ULV • Intel Core Duo processor LV and ULV • Intel Core Solo processor ULV • Celeron M processor ULV • 533-MHz and 667-MHz front side bus (FSB) support
System Memory Support	<ul style="list-style-type: none"> • Supports single-channel DDR2 SDRAM only • Maximum Memory supported 2 GB • Memory Channel Topologies supported:- <ul style="list-style-type: none"> • Single-channel with 1 SO-DIMM only (up to 1 GB) • Single-channel with 1 SO-DIMM (up to 1 GB) and Memory Down (up to 1 GB) • Support for DDR2 at 400 MHz and 533 MHz
Internal Graphics	<ul style="list-style-type: none"> • 166-MHz core render clock and 200 MHz core display clock at 1.05-V core voltage only • Support for only one SDVO port • SDVO slot reversal not supported • Support for dual-channel LVDS resolutions up to UXGA • Support for CRT resolutions up to QXGA • TV support for HDTV
DMI	<ul style="list-style-type: none"> • DMI lane width support for x2 only • DMI Lane reversal not supported Package

Item	Specification
Package	<ul style="list-style-type: none"> FCBGA Ball Count: 998 balls Package Size: 27 mm x 27 mm Ball pitch: 0.8-mm uniform pitch

System Clock

Item	Specification
System clock chip	Built in
Package	56 pin TSSOP
Clock Synthesizer	<ul style="list-style-type: none"> 100Mhz for CPU 100MHz clock buffer for PCI-E and ICH7M SATA 96MHz ICH7M 48Mhz for USB clock inside ICH7M 33Mhz PCI clock for PC device, LPC 14.31818Mhz for ICH7M and Audio
Power	3.3V
Features	<ul style="list-style-type: none"> Support spread spectrum function, for reducing EMI Support SM bus interface

Crystal and Oscillator

Item	Specification
Features	<ul style="list-style-type: none"> 14.31818Mhz crystal for clock chip 32.768Khz crystal for ICH7M and WPCE775L 25MHZ crystal for LAN RTL8102EL

System Memory

Item	Specification
Memory controller	Built in
Memory size	512MB or 1GB DDR2 RAM (if 2Gb die support is available)
DIMM socket number	1
Supports memory size per socket	1GB
Supports maximum memory size	1GB
Supports DIMM type	DDR II 533Mhz SDRAM memory interface design
Supports DIMM Speed	533Mhz SDRAM

System Storage

Item	Specification
SSD	<ul style="list-style-type: none"> USB or ZIF connector (PATA compatible) Interface 2GB, 4GB or 8GB USB connector BTO (not user selectable)
HDD	<ul style="list-style-type: none"> 9.5mm height, 2.5" HDD Easily removable no more than two screws SATA bus 80GB/100GB/120GB/160GB and above 5400 and 7200 rpm (follow HDD roadmap) SATA connector BTO (not user selectable)

Hard Disk Drive Interface

Item	Specification			
Vendor & Model Name	Seagate ST9120817AS	Toshiba MK1252GSX	WD WD1200BEVS	WD WD1200BEVT
Capacity (MB)	120	120	120	120
Bytes per sector	512	512	512	512
Data heads	2	2	2	2
Drive Format				
Disks	1	1	1	1
Spindle speed (RPM)	5400	5400	5400	5400
Performance Specifications				
Buffer size	8 MB	8 MB	8 MB	8 MB
Interface	SATA	SATA	SATA	SATA
Internal transfer rate (Mbits/sec, max)	778	400 ~ 794 typical	850 Mbits/s maximum	850 Mbits/s maximum
I/O data transfer rate (Mbytes/sec max)	300	300	150 maximum	300 maximum
DC Power Requirements				
Voltage tolerance	5V ±5%	5V ±5%	5V ±5%	5V ±5%

Thermal Sensor Control

Item	Specification
Thermal Sensor Chip	G780
Package	8-pin MSOP
Features	Thermal sensor control
Interface	I ² C bus, address: 98h

BIOS

Item	Specification
BIOS vendor	InSyde
BIOS Version	v0.2103
BIOS ROM type	W25X80VSSIG
BIOS ROM size	1Mb CMOS Boot Block Flash Memory
BIOS package	8 pin SOIC
Block Size	64 Kb per block

Item	Specification
Supply Current	Active current =15 mA (Typical) Standby current=4 μ A (Typical)

LCD 8.9"

Item	Specification
Vendor/model name	AOU B089AW01 V1
Screen Diagonal (mm)	226.06
Active Area (mm)	195.07(H) X 113.4(V)
Display resolution (pixels)	1024x3(RGB) x 600
Pixel Pitch (mm)	0.1905 (H) x 0.189 (V)
Pixel Arrangement	R.G.B. Vertical Stripe
Display Mode	Normally White
Typical White Luminance (cd/m ²) also called Brightness	180 typ. (center) 150 min. (center)
Luminance Uniformity	Max. (5 points)
Contrast Ratio	300 typ
Response Time (Optical Rise Time/Fall Time) msec	30 typ / 50 max
Nominal Input Voltage VDD	+3.3 typ.
Typical Power Consumption (watt)	3.0 max. (Include Logic and Black Light power)
Weight (without inverter)	190 max.
Physical Size (mm)	Max: 213.66 (L) 129.85 (W) 5.45 (T) Typical: 213.36 (L) 129.55 (W) 5.15 (T)
Electrical Interface	1 channel LVDS
Support Color	262K colors (RGB 6-bit)
Viewing Angle (degree) Horizontal (Right) CR = 10 (Left) Vertical (Upper) CR = 10 (Lower)	45, 45 15, 35
Temperature Range (°C) Operating Storage (shipping)	0 to +50 -20 to +65
RoHS Compliance	RoHS Compliance

KBC

Item	Specification
Chipset	WPCE775L
Features	<ul style="list-style-type: none">• Host interface, base on Intel's LPC Interface specification Revision 1.0• PC01 REV 0.3 and ACPI 1.0b compliant• 16-bit RISC core, with 2 Mbyte address space, and running at up to 20 MHZ• Software and Hardware controlled clock throttling• Share BIOS flash memory (internal and/or external)• Y2K- compliant• 84 GPIO ports with variety of wake-up events• Extremely low current consumption in idle mode• JTAG-base debugger interface• 176 pin LQFP package

Audio Codec and Amplifier

Item	Specification
Audio Controller	Realtek ALC268 Azadia Codec and Amplifier G1441
Features	<ul style="list-style-type: none">• HD Audio• SNR > 85, High-performance DACs with 95dB SNR (A-Weighting), ADCs with 85dB SNR (A-Weighting)• Internal Digital Microphone• Two speakers, at least 1.0W for each• 1* Analog Microphone, 1*Headphone jack

LAN Interface

Item	Specification
LAN Chipset	Realtek solution RTL8102EL
Features	<ul style="list-style-type: none">• Support WOL from S53• File deployment support• LDCM support

Keyboard

Item	Specification
Type	New Acer flat keyboard
Total number of keypads	84
Windows logo key	Yes
Internal & external keyboard work simultaneously	Plug USB keyboard to the USB port directly: Yes

Mini Card

Item	Specification
Number Supported	2
Features	<ul style="list-style-type: none">• 2 mini card slot (1 for 3G and 1 for WLAN or WLAN/ WiMax)• Embedded 3G module and built-in 1 antenna (combo-wireless+3G) on top/side of LCD

Camera

Item	Specification
Maximum Module Form Factor	65*8*4.74 mm3
Sensor Type and Resolution	Color CMOS, VGA(640x480)
ISP	USB 2.0 high speed
Focusing Type	Fix Focus
F/N	2.8±5%
Focusing Range	30 cm ~infinity (theory) focus at 48 cm
Format of Image Output Data	YUV
Frame Rate	VGA: 30 fps (MAX.) @USB2.0 high speed
Operation Voltage	Total Supply Voltage: 3.3V
	ISP: 3.3, 1.8V
	CMOS Sensor: 2.8V, 1.8V
System Interfacing	USB 2.0 (High Speed)
Board Connector Type	Wire to board 5-pin connector
PCB layer	4 layers
Power consumption	Operation: Around 400mW @VGA 30fps
	Suspend: < 500uA in Vista
Weight	1.8 g

3G Card

Item	Specification
Type	
Features	<ul style="list-style-type: none"> • 3G card in mini-PCI card size • Control by USB interface • User accessible SIM card by battery remove • Antenna: Has to be placed on the sides of LCD in A/B cover

Wireless LAN

Item	Specification
Type	Foxconn FOX_ATH_XB63 Foxconn Atheros XB63
Features	<ul style="list-style-type: none"> • Manufacturing option: mini-card • 802.11b/g (3rd Party) • Built-in 2 Antenna • Antenna: Has to be placed on the top of LCD on the sides of LCD latch

Battery

Item	Specification	
Vendor & model name	Celexper UM-2008A, Panasonic UM-2008A, Sanyo UM-2008A, Simplo UM-2008A	Panasonic UM-2008B, Sanyo UM-2008B
Battery Type	Li-Ion 3S1P	Li-Ion 3S2P
Pack capacity	4400mAh	5200mAh
Number of battery cell	3	6
Package configuration	3S1P	3S2P

System Utilities

BIOS Setup Utility

The BIOS Setup Utility is a hardware configuration program built into your computer's BIOS (Basic Input/Output System).

Your computer is already properly configured and optimized, and you do not need to run this utility. However, if you encounter configuration problems, you may need to run Setup. Please also refer to Chapter 4 Troubleshooting when problem arises.

To activate the BIOS Utility, press **F2** during POST (when "Press <F2> to enter Setup" message is prompted on the bottom of screen).

Press **F2** to enter setup. The default parameter of F12 Boot Menu is set to "disabled". If you want to change boot device without entering BIOS Setup Utility, please set the parameter to "enabled".

Press <F12> during POST to enter multi-boot menu. In this menu, user can change boot device without entering BIOS SETUP Utility.

Navigating the BIOS Utility

There are six menu options: Information, Main, Advanced, Security, Boot, and Exit.

Follow these instructions:

- To choose a menu, use the left and right arrow keys.
- To choose an item, use the up and down arrow keys.
- To change the value of a parameter, press **F5** or **F6**.
- A plus sign (+) indicates the item has sub-items. Press **Enter** to expand this item.
- Press **Esc** while you are in any of the menu options to go to the Exit menu.
- In any menu, you can load default settings by pressing **F9**. You can also press **F10** to save any changes made and exit the BIOS Setup Utility.

NOTE: You can change the value of a parameter if it is enclosed in square brackets. Navigation keys for a particular menu are shown on the bottom of the screen. Help for parameters are found in the Item Specific Help part of the screen. Read this carefully when making changes to parameter values. **Please note that system information is subject to different models.**

Information

The Information screen displays a summary of your computer hardware information.

InsydeH20 Setup Utility		Rev. 3.5
Information	Main	Security Boot Exit
CPU Type:	Genuine Intel (R) CPU N270	
CPU Speed:	1.60GHz	
HDD Model Name:	INTEL Castle Point	
HDD Serial Number:	00008030320000000000	
System BIOS Version:	v0.2103	
VGA BIOS Version:	Intel V1585	
Serial Number:	ZG008160067	
Asset Tag Number:		
Product Name:		
Manufacturer Name:	Acer	
UUID:	405FE2E9A4E1D4118251001E684CE894	
F1 Help	↑↓ Select Item	F5/F6 Change Values F9 Setup Default
ESC Exit	←→ Select Menu	Enter Select▶SubMenu F10 Save and Exit

NOTE: The system information is subject to different models.

Parameter	Description
CPU Type	This field shows the CPU type and speed of the system.
CPU Speed	This field shows the speed of the CPU.
HDD Model Name	This field shows the model name of HDD installed on primary IDE master.
HDD Serial Number	This field displays the serial number of HDD installed on primary IDE master.
System BIOS Version	Displays system BIOS version.
VGA BIOS Version	This field displays the VGA firmware version of the system.
Serial Number	This field displays the serial number of this unit.
Asset Tag Number	This field displays the asset tag number of the system.
Product Name	This field shows product name of the system.
Manufacturer Name	This field displays the manufacturer of this system.
UUID Number	Universally Unique Identifier (UUID) is an identifier standard used in software construction, standardized by the Open Software Foundation (OSF) as part of the Distributed Computing Environment (DCE).

Main

The Main screen allows the user to set the system time and date as well as enable and disable boot option and recovery.

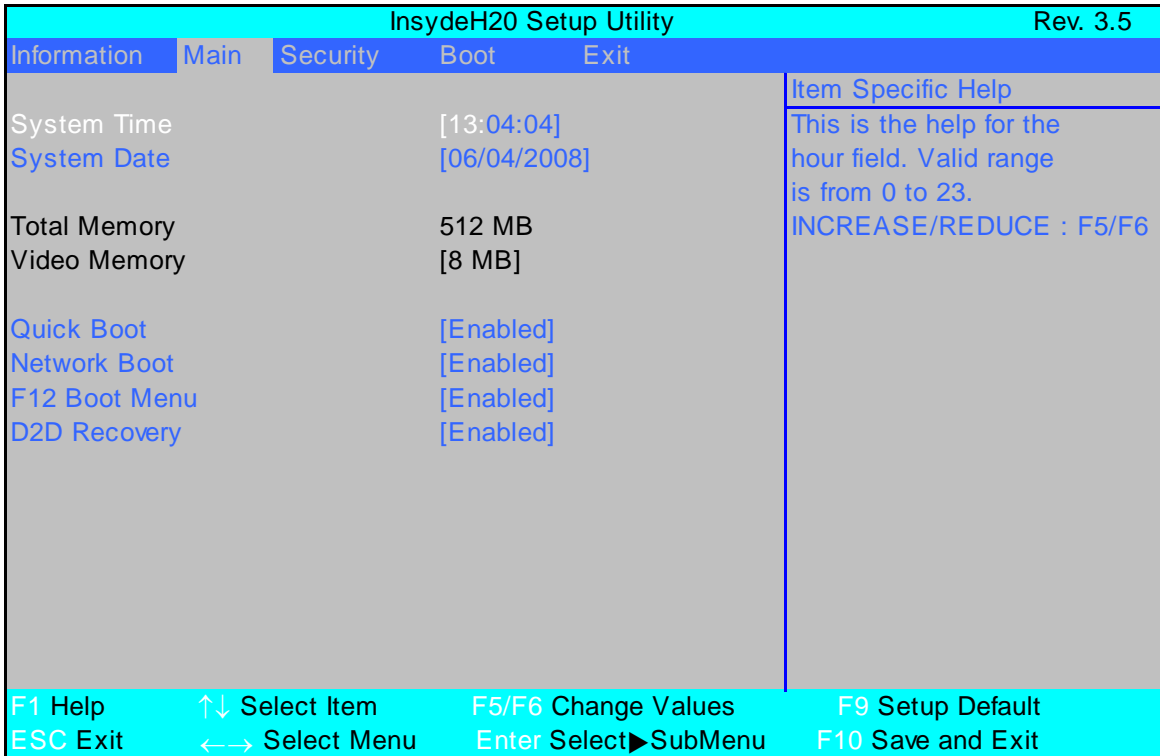

NOTE: The screen above is for your reference only. Actual values may differ.

The table below describes the parameters in this screen. Settings in **boldface** are the default and suggested parameter settings.

Parameter	Description	Format/Option
System Time	Sets the system time. The hours are displayed with 24-hour format.	Format: HH:MM:SS (hour:minute:second)
System Date	Sets the system date.	Format MM/DD/YYYY (month/day/year)
Total Memory	This field reports the memory size of the system. Memory size is fixed to 3017 MB.	N/A
Video Memory	Shows the video memory size. VGA Memory size=32 MB	N/A
Quick Boot	Allows startup to skip certain tests while booting, decreasing the time needed to boot the system.	Option: Enabled or Disabled
Network Boot	Enables, disables the system boot from LAN (remote server).	Option: Enabled or Disabled
F12 Boot Menu	Enables, disables Boot Menu during POST.	Option: Enabled or Enabled
D2D Recovery	Enables, disables D2D Recovery function. The function allows the user to create a hidden partition on hard disc drive to store operation system and restore the system to factory defaults.	Option: Enabled or Disabled

Security

The Security screen contains parameters that help safeguard and protect your computer from unauthorized use.

InsydeH20 Setup Utility				Rev. 3.5
Information	Main	Security	Boot	Exit
Supervisor Password Is: Clear				Item Specific Help Install or Change the password and the length than eight words.
User Password Is: Clear				
Set Supervisor Password				
Set User Password				
Power on password [Enabled]				
F1 Help	↑↓ Select Item	F5/F6 Change Values	F9 Setup Default	
ESC Exit	←→ Select Menu	Enter Select▶ SubMenu	F10 Save and Exit	

The table below describes the parameters in this screen. Settings in **boldface** are the default and suggested parameter settings.

Parameter	Description	Option
Supervisor Password Is	Shows the setting of the Supervisor password	Clear or Set
User Password Is	Shows the setting of the user password.	Clear or Set
Set Supervisor Password	Press Enter to set the supervisor password. When set, this password protects the BIOS Setup Utility from unauthorized access. The user can not either enter the Setup menu nor change the value of parameters.	
Set User Password	Press Enter to set the user password. When user password is set, this password protects the BIOS Setup Utility from unauthorized access. The user can enter Setup menu only and does not have right to change the value of parameters.	
Power on password	Defines whether a password is required or not while the events defined in this group happened. The following sub-options are all requires the Supervisor password for changes and should be grayed out if the user password was used to enter setup.	Enabled or Disabled

NOTE: When you are prompted to enter a password, you have three tries before the system halts. Don't forget your password. If you forget your password, you may have to return your notebook computer to your dealer to reset it.

Setting a Password

Follow these steps as you set the user or the supervisor password:

1. Use the ↑ and ↓ keys to highlight the Set Supervisor Password parameter and press the **Enter** key. The Set Supervisor Password box appears:

Set Supervisor Password		
Enter New Password	[]
Confirm New Password	[]

2. Type a password in the “Enter New Password” field. The password length can not exceeds 8 alphanumeric characters (A-Z, a-z, 0-9, not case sensitive). Retype the password in the “Confirm New Password” field.

IMPORTANT: Be very careful when typing your password because the characters do not appear on the screen.

3. Press **Enter**. After setting the password, the computer sets the User Password parameter to “Set”.
4. If desired, you can opt to enable the Password on boot parameter.
5. When you are done, press F10 to save the changes and exit the BIOS Setup Utility.

Removing a Password

Follow these steps:

1. Use the ↑ and ↓ keys to highlight the Set Supervisor Password parameter and press the **Enter** key. The Set Password box appears:

Set Supervisor Password		
Enter current password	[]
Enter New Password	[]
Confirm New Password	[]

2. Type the current password in the Enter Current Password field and press **Enter**.
3. Press **Enter** twice **without** typing anything in the Enter New Password and Confirm New Password fields. The computer then sets the Supervisor Password parameter to “Clear”.
4. When you have changed the settings, press u to save the changes and exit the BIOS Setup Utility.

Changing a Password

1. Use the ↑ and ↓ keys to highlight the Set Supervisor Password parameter and press the **Enter** key. The Set Password box appears.

Set Supervisor Password		
Enter current password	[]
Enter New Password	[]
Confirm New Password	[]

2. Type the current password in the Enter Current Password field and press **Enter**.
3. Type a password in the Enter New Password field. Retype the password in the Confirm New Password field.
4. Press **Enter**. After setting the password, the computer sets the User Password parameter to “Set”.
5. If desired, you can enable the Password on boot parameter.
6. When you are done, press F10 to save the changes and exit the BIOS Setup Utility.

If the verification is OK, the screen will display as following.

Setup Notice
Changes have been saved.
[continue]

The password setting is complete after the user presses **Enter**.

If the current password entered does not match the actual current password, the screen will show you the Setup Warning.

Setup Warning
Invalid password
Re-enter Password
[continue]

If the new password and confirm new password strings do not match, the screen will display the following message.

Setup Warning
Password do not match
Re-enter Password

Boot

This menu allows the user to decide the order of boot devices to load the operating system. Bootable devices includes the USB diskette drives, the onboard hard disk drive and the DVD drive in the module bay.

InsydeH20 Setup Utility				Rev. 3.5
Information	Main	Security	Boot	Exit
Boot priority order:				Item Specific Help
1. IDE0 : INTEL Castle Point				Use <↑> or <↓> to select a device, then press <F5> to move it down the list, or <F6> to move it up the list. Press <Esc> to escape the menu
2. IDE1 :				
3. USB FDD :				
4. USB HDD :				
5. Network Boot : LEGACY PCI DEVICE				
6. USB CDROM :				
F1 Help	↑↓ Select Item	F5/F6 Change Values	F9 Setup Default	
ESC Exit	←→ Select Menu	Enter Select	▶ SubMenu	F10 Save and Exit

Exit

The Exit screen allows you to save or discard any changes you made and quit the BIOS Utility.

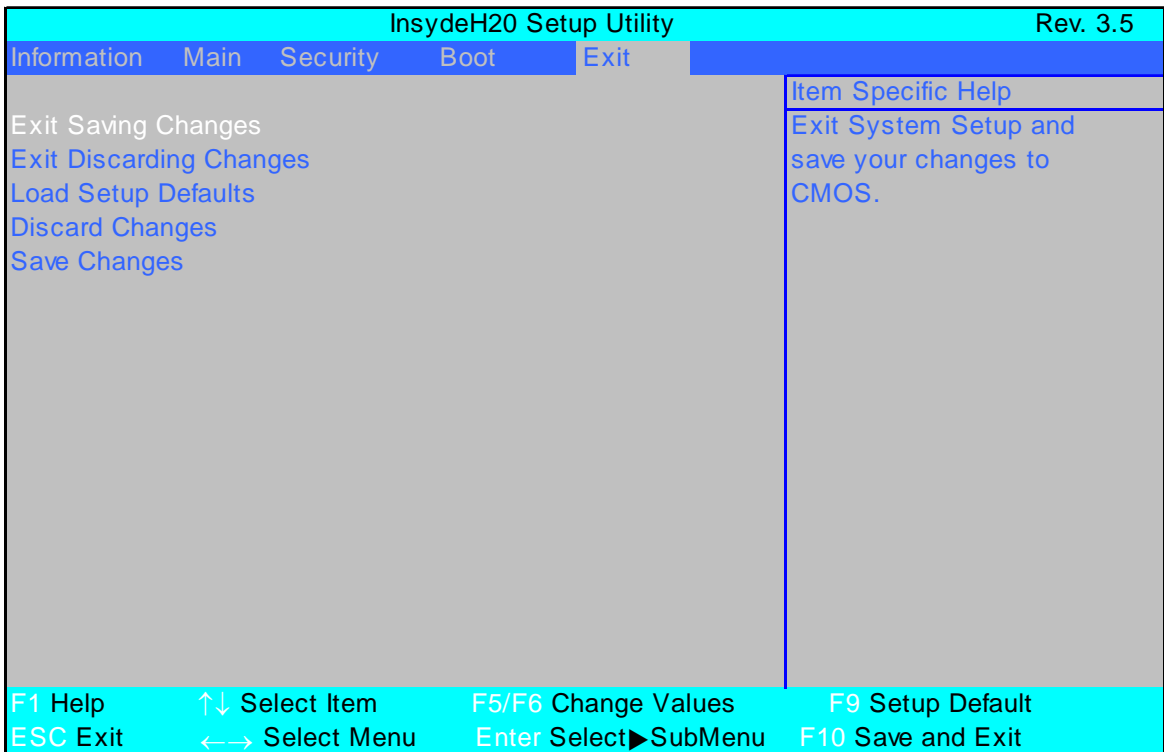

The table below describes the parameters in this screen.

Parameter	Description
Exit Saving Changes	Exit System Setup and save your changes to CMOS.
Exit Discarding Changes	Exit utility without saving setup data to CMOS.
Load Setup Default	Load default values for all SETUP item.
Discard Changes	Load previous values from CMOS for all SETUP items.
Save Changes	Save Setup Data to CMOS.

BIOS Flash Utility

The BIOS flash memory update is required for the following conditions:

- New versions of system programs
- New features or options
- Restore a BIOS when it becomes corrupted.

Use the Phlash utility to update the system BIOS flash ROM.

NOTE: Create a **Crisis Recovery Media** (such as USB HDD) before you use the Phlash utility.

NOTE: Do not install memory-related drivers (XMS, EMS, DPMI) when you use the Phlash.

NOTE: Please use the AC adaptor power supply when you run the Phlash utility. If the battery pack does not contain enough power to finish BIOS flash, the system will not boot as the BIOS is not loaded.

Perform the following steps to use the Flash Utility:

1. Press F2 during boot to enter the Setup Menu.
2. Select **Boot Menu** to modify the boot priority order, for example, if using USB HDD to Update BIOS, move USB HDD to position 1.

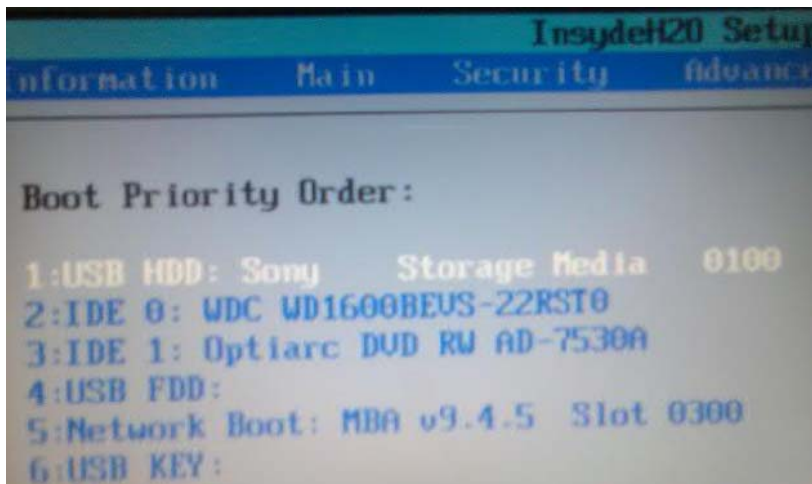

3. Execute the **IFLASH.BAT** batch file to update BIOS (Read xxxxx.fd to Memory).



4. In flash BIOS, the message **Please do not remove AC Power Source** displays.

NOTE: If the AC power is not connected, the following message displays.

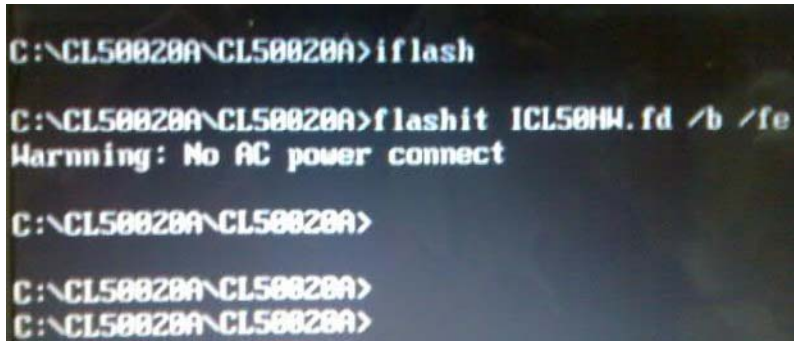

```
C:\CL50020A\CL50020A>iflash
C:\CL50020A\CL50020A>flashit ICL50HW.fd /b /fe
Warning: No AC power connect
C:\CL50020A\CL50020A>
C:\CL50020A\CL50020A>
C:\CL50020A\CL50020A>
```

Plug in the AC power to continue.

5. Flash is complete when the following message displays.

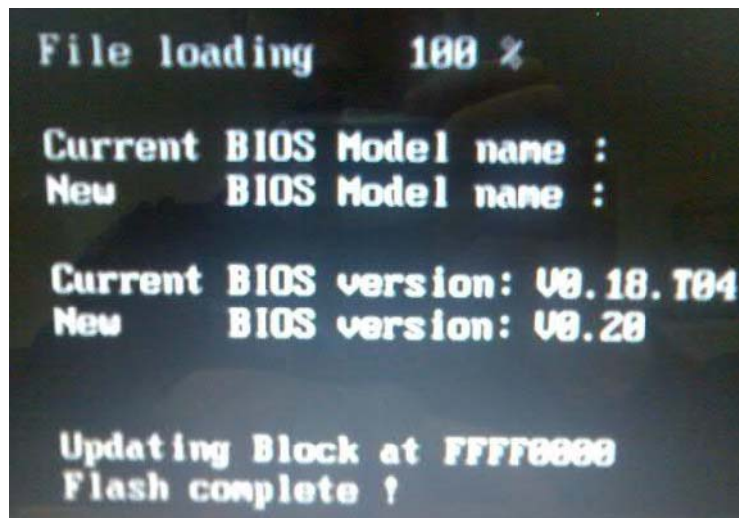

```
File loading 100 %
Current BIOS Model name :
New BIOS Model name :
Current BIOS version: V0.18.T04
New BIOS version: V0.20
Updating Block at FFFF0000
Flash complete !
```

6. Shutdown or reboot base on iflash.bat command.

Remove HDD/BIOS Utility

This section provide you with removing HDD/BIOS method:

Remove HDD Password:

- If you key in wrong HDD password three times, Hdd password error code displays. See the image below.



To reset the HDD password, run HDD_PW.EXE as follows:

1. Key in **hdd_pw 15494 0**
2. Press 2.
3. Select one upper-case string from the list.



4. Reboot system and key in the selected string (0KJFN42 or UVEIQ96) on the HDD User Password screen.



Remove BIOS Password:

If you key in the wrong Supervisor Password three times, System Disabled displays on the screen. See the image below.

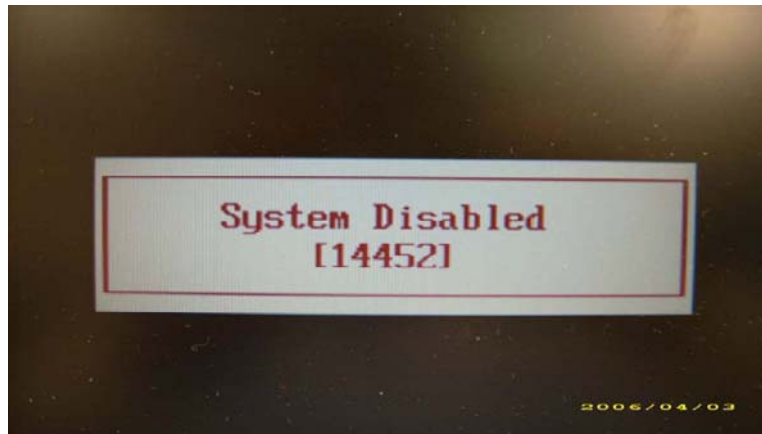

To reset the BIOS password, run BIOS_PW.EXE as follows:

1. Key in **bios_pw 14452 0**
2. Select one string from the list.

```
C:\WINDOWS\system32\cmd.exe
Microsoft Windows XP [Version 5.1.2600]
(C) Copyright 1985-2001 Microsoft Corp.

C:\Documents and Settings\M54>d:
D:\>bios_pw 14452 0
unlock6.exe v1.0 1 July 1997
qj119900
0?yqmjd
c.jl14tm
6mbzjaj
D:\>
```

-
3. Reboot the system and key in the selected string (qjjg9vy, 07yqmjd etc.) for the BIOS user password.



Machine Disassembly and Replacement

This chapter contains step-by-step procedures on how to disassemble the notebook computer for maintenance and troubleshooting.

Disassembly Requirements

To disassemble the computer, you need the following tools:

- Wrist grounding strap and conductive mat for preventing electrostatic discharge
- Flat screwdriver
- Philips screwdriver
- Plastic flat screwdriver
- Plastic tweezers

NOTE: The screws for the different components vary in size. During the disassembly process, group the screws with the corresponding components to avoid mismatch when putting back the components.

Related Information

Please note that the images were taken using the HDD SKU, unless otherwise specified, and may differ slightly from a SSD SKU.

The product previews seen in the disassembly procedures may not represent the final product color.

General Information

Pre-disassembly Instructions

Before proceeding with the disassembly procedure, make sure that you do the following:

1. Turn off the power to the system and all peripherals.
2. Unplug the AC adapter and all power and signal cables from the system.



3. Place the system on a flat, stable surface.
4. Remove the battery pack.

Disassembly Process

The disassembly process is divided into the following sections:

- Upper cover disassembly
- LCD module disassembly
- Main unit disassembly

The flowcharts provided in the succeeding disassembly sections illustrate the entire disassembly sequence. Observe the order of the sequence to avoid damage to any of the hardware components. For example, if you want to remove the main board, you must first remove the keyboard, then disassemble the inside assembly frame in that order.

Main Screw List

Screw	Quantity	Part Number
M2*3 (NL)	25	86.S0207.001
M2.5*4 (NL)	2	86.D01V7.001
M2*4-NI (NL)	5	86.W0107.003
M2*5 (NL)	20	86.TG607.004
M3*3.5	4	86.TDY07.003

External Module Disassembly Process

External Modules Disassembly Flowchart

The flowchart below gives you a graphic representation on the entire disassembly sequence and instructs you on the components that need to be removed during servicing. Disassembly is divided into two tiers. Tier 1 comprises of FRU parts that do not require complete disassembly of the computer. Tier 2 incorporates the remaining FRU parts that require complete disassembly.

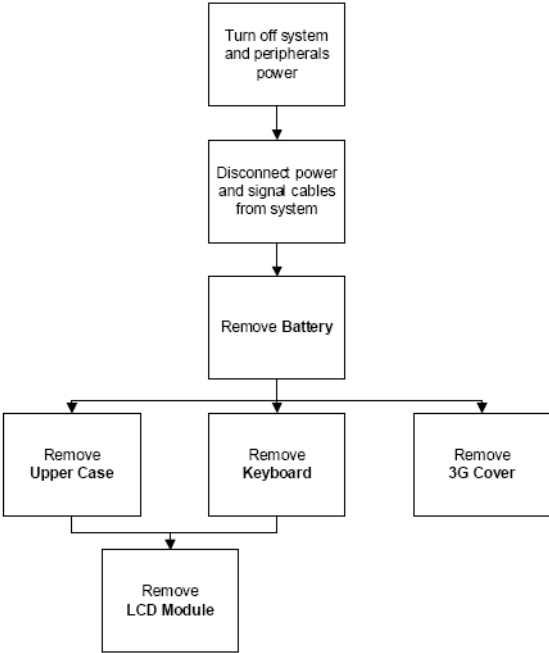

Screw List

Step	Screw	Quantity	Color	Part No.
Upper Cover	M2*5	5	Black	86.TG607.004
	M2*3 (NL)	3	Black	86.S0207.001

Removing the Battery Pack

1. Turn computer over.
2. Slide the battery lock/unlock latch to the unlock position.



3. Slide and hold the battery release latch to the release position (1), then slide out the battery pack from the main unit (2).



Removing the 3G Cover

1. Remove the Battery Pack. See “Removing the Battery Pack” on page 36.
2. Loosen the ten captive screws from the Memory, HDD1, and HDD2 Covers.
3. Remove the two captive screws.



4. Lift the 3G cover up to remove.



Removing the Keyboard

1. Turn the computer rightside up and unlock the three (3) securing latches.



2. Grasp the keyboard and lift up to remove.



3. Lift the keyboard over and disconnect the keyboard FFC.

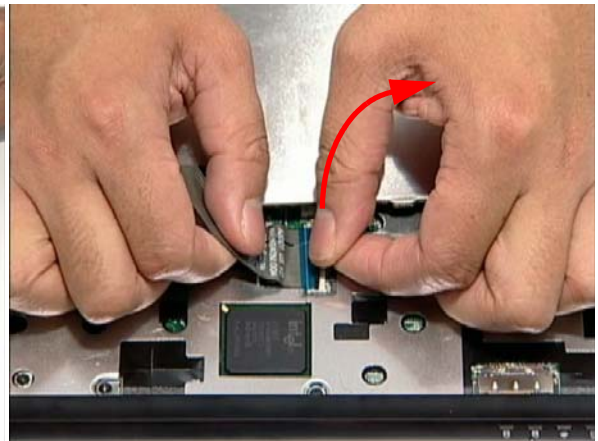



4. Remove the keyboard and place it on a clean surface.

Removing the Upper and Lower Covers

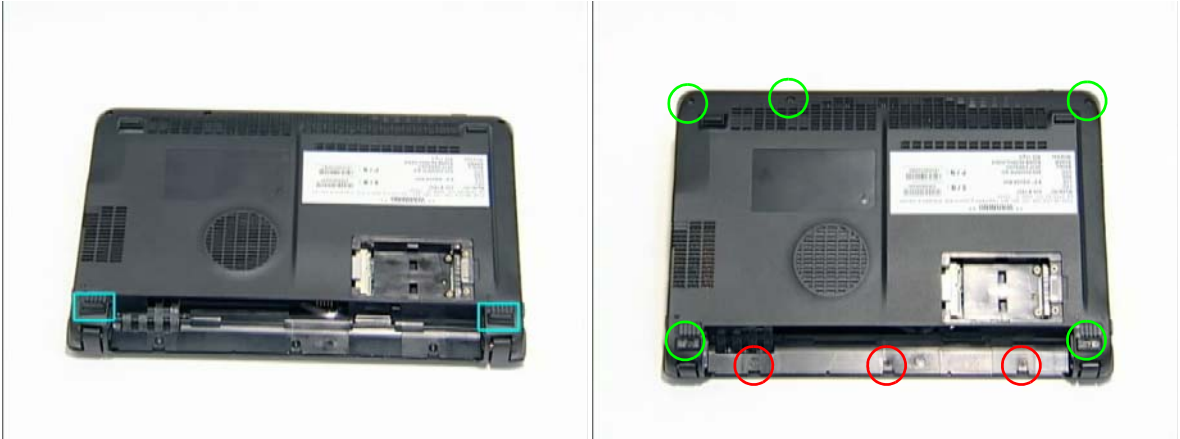
1. Remove the Battery Pack. See “Removing the Battery Pack” on page 36.
2. Turn the computer upside down. Remove the three securing screws under the battery pack.
3. Remove the two rubber foot pads and the eight securing screws.





Step	Size	Quantity	Screw Type
Upper Cover	M2*3 (NL) Red callout	3	
Upper Cover	M2*5 (NL) Green callout	5	

4. Turn the computer rightside up and disconnect the TouchPad FFC.

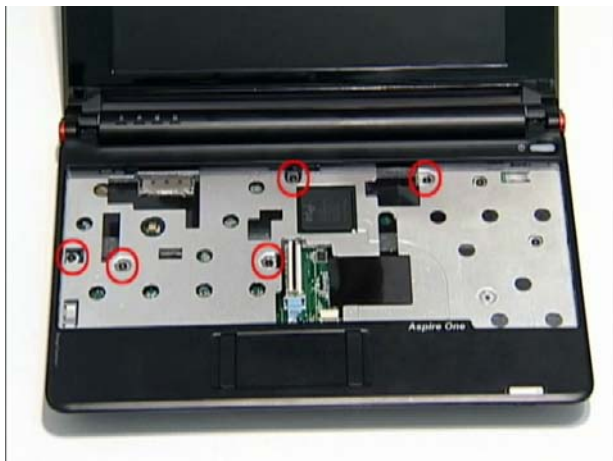

5. Remove the five (5) securing screws.



Step	Size	Quantity	Screw Type
Upper Cover	M2*5 (NL)	5	

6. Grasp the bottom of the upper cover and pry apart.

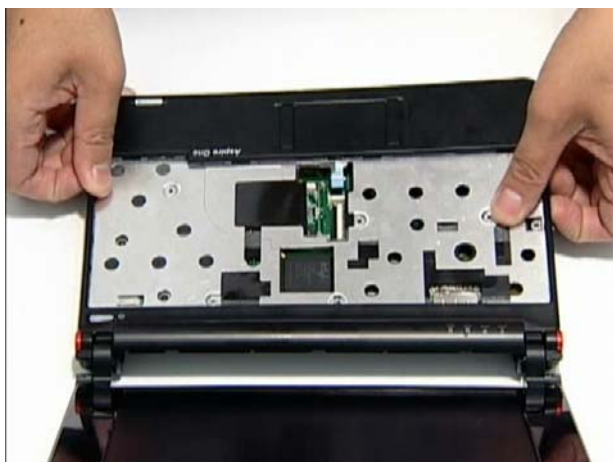

7. Lift the upper cover to remove completely.

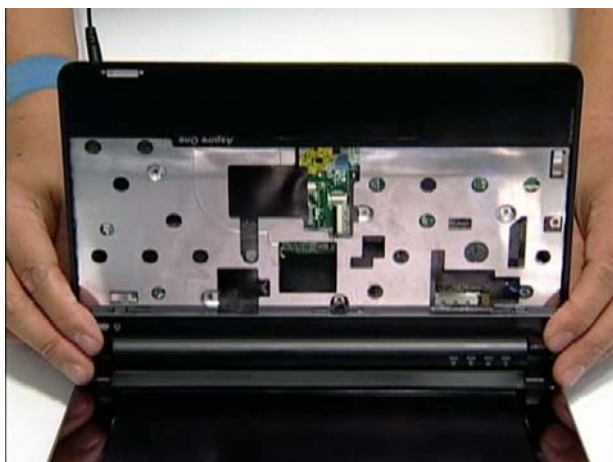

LCD Module Disassembly Process

LCD Module Disassembly Flowchart

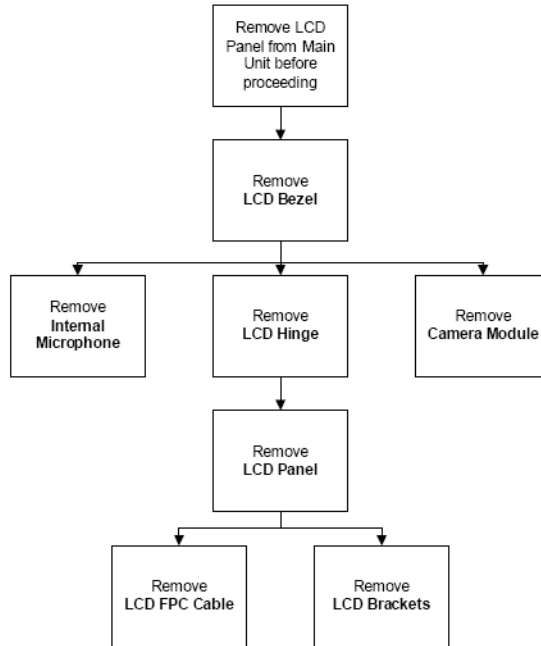

Screw List

Step	Screw	Quantity	Color	Part No.
LCD Bezel	M2*5 (NL)	6	Black	86.TG607.004
LCD Module	M2*5 (NL)	4	Black	86.TG607.004
LCD Panel	M2*4 (NL)	5	Black	86.W0107.003
LCD Brackets	M2*3 (NL)	4	Black	86.TG607.004

Removing the LCD Module

1. Remove the Upper Cover. See “Removing the Upper and Lower Covers” on page 39.
2. Disconnect the LCD cable from its connector



3. Disconnect and remove the antenna cables from the housing well.

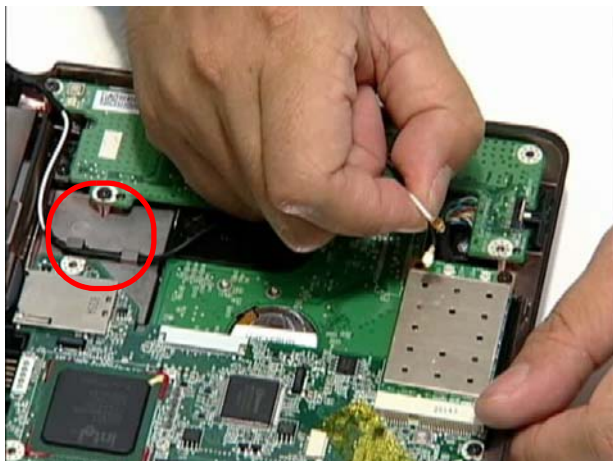
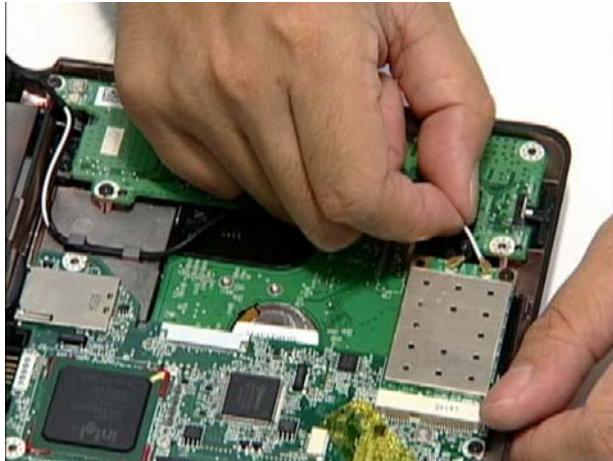

NOTE: Main cable is black. The Auxiliary cable is white.

4. Remove the four securing screws from the hinges.



Step	Size	Quantity	Screw Type
LCD Module	M2*5 (NL)	4	

5. Tilt the LCD module so it sits at a 90 degree angle.

IMPORTANT: Ensure all cables are clear of the lower cover before removing the LCD module.

6. Grasp the module by both sides and lift upwards.



Removing the LCD Bezel

1. Remove the LCD Module. See "Removing the LCD Module" on page 42.
2. Remove the four round and the two semi-rectangular screw caps.
3. Remove the six (6) securing screws.



Step	Size	Quantity	Screw Type
LCD Bezel	M2*5 (NL)	6	

4. Starting from the inside edges, pry the inside of the bezel upwards from the panel. Continue moving left until the bezel is removed. If necessary, use a plastic pry to release the corners of the bezel.

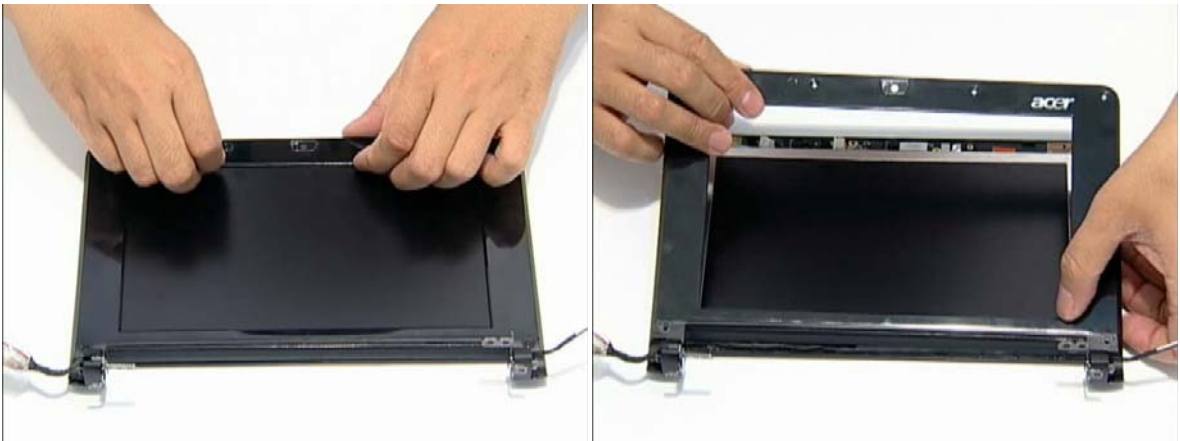

5. Lift up the bezel and remove it from the LCD Module.

Removing the Camera Board

1. Remove the LCD Bezel. See “Removing the LCD Bezel” on page 44.
2. Disconnect the Camera Module cable from its connector as shown.

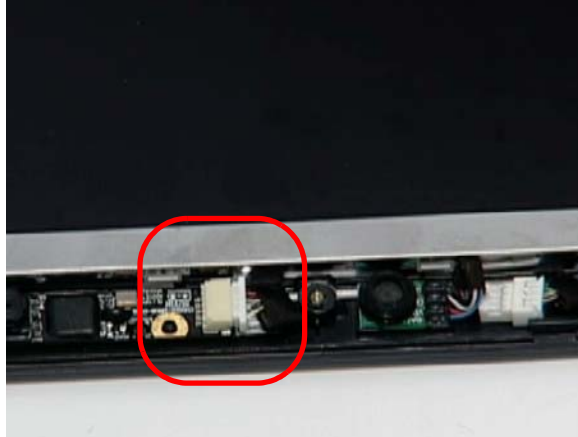

3. Remove the camera board from the LCD cover.



Removing the MIC Board

1. Remove the LCD Bezel. See "Removing the LCD Bezel" on page 44.
2. Disconnect the MIC cable from its connector as shown.

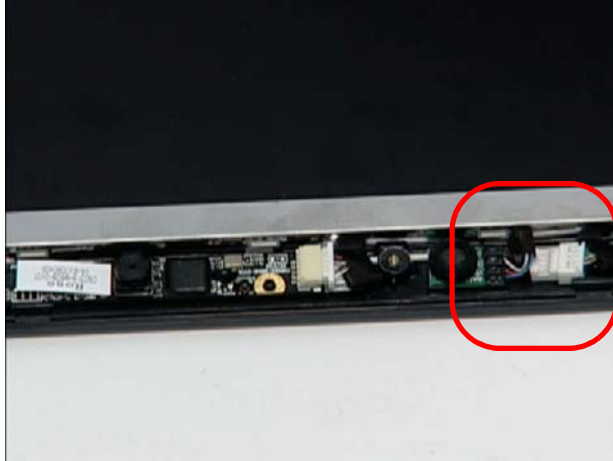



3. Remove the MIC board from the LCD cover.

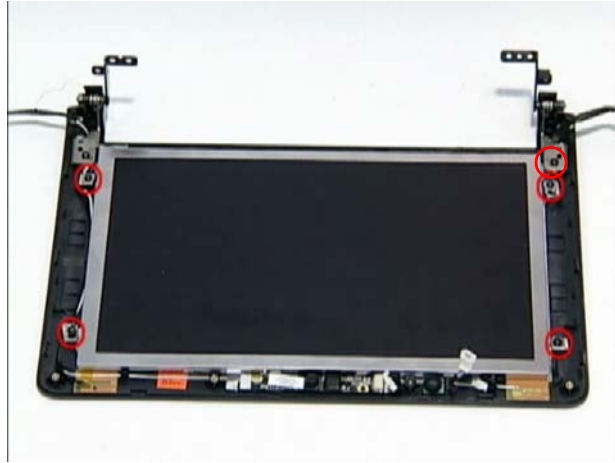

Removing the LCD Panel

1. Remove the LCD Bezel. See "Removing the LCD Bezel" on page 44.
2. Disconnect the MIC cable. See "Removing the MIC Board" on page 46.
3. Remove the five (5) securing screws from the LCD Module.



Step	Size	Quantity	Screw Type
LCD Panel	M2*4 (NL)	5	

4. Grasp the left hinge and pivot down before pulling up.
5. Remove it from its housing well.

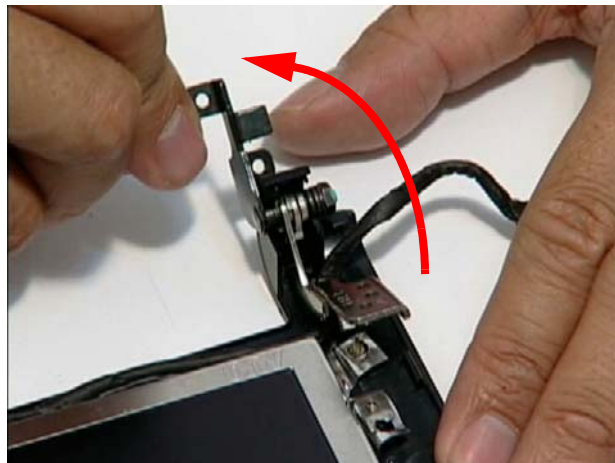

6. Hold the LCD Panel from the sides and lift to remove. Place it on a clean surface.



Removing the LCD Brackets and FPC Cable

1. Remove the LCD Panel. See "Removing the LCD Panel" on page 47.
2. Turn the LCD panel over on a clean surface. Remove the adhesive strips securing the LCD cable.

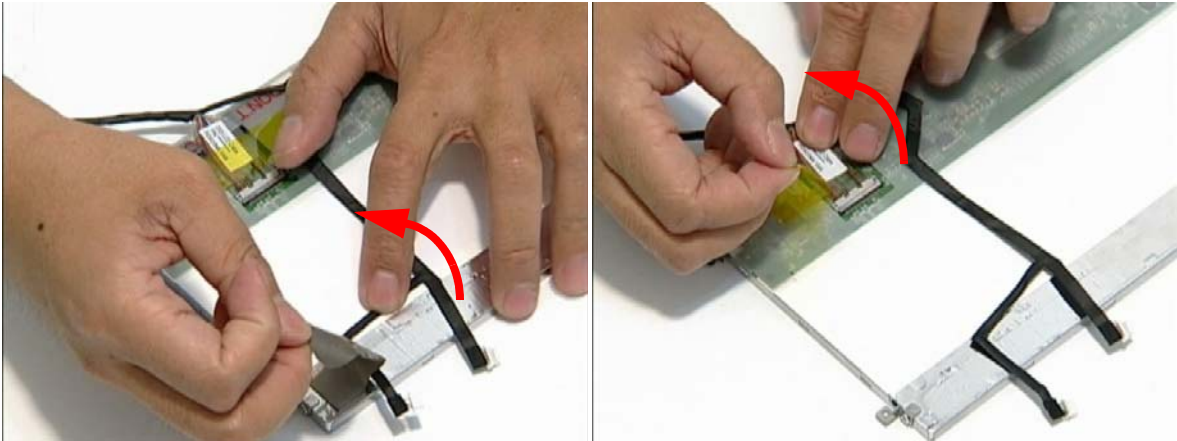

3. Disconnect the LCD cable from its connector as shown.

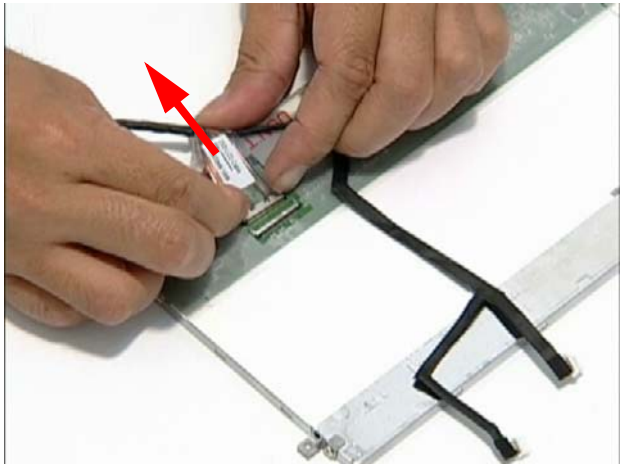

4. Remove the four securing screws (two each side) from the LCD Panel brackets.



Step	Size	Quantity	Screw Type
LCD Brackets	M2*3 NL	4	

NOTE: The brackets are paired diagonally and marked as shown below.

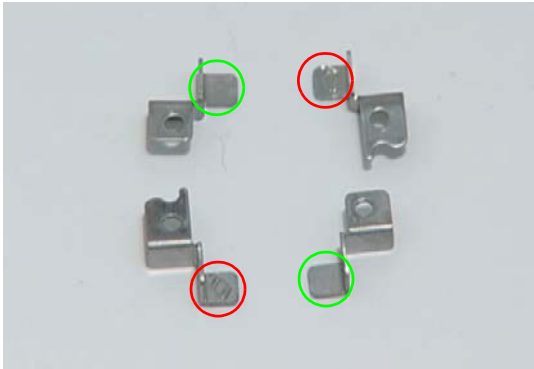

Main Unit Disassembly Process

Main Unit Disassembly Flowchart

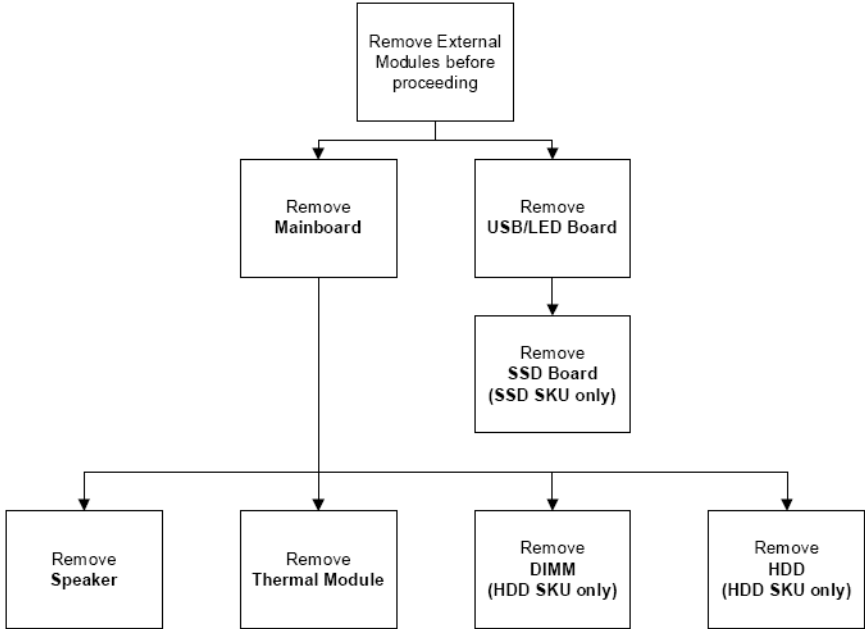



Screw List

Step	Screw	Quantity	Color	Part No.
WLAN	M2*3 (NL)	1	Black	86.S0207.001
USB/LED/Power Board (HDD SKU)	M2*3 (NL)	3	Black	86.S0207.001
USB/LED/Power Board (SSD SKU)	M2*3 (NL)	4	Black	86.S0207.001
SSD Module	M2*3	2	Black	86.S0207.001
Mainboard	M2*3	1	Black	86.S0207.001
Speaker Module	M2*3	4	Black	86.S0207.001
HDD Module	M2.5*4	2	Black	86.D01V7.001
HDD Carrier	M3*3.5	4	Black	86.TDY07.003
Thermal Module	M2*3	3	Black	86.S0207.001

Removing the WLAN Module

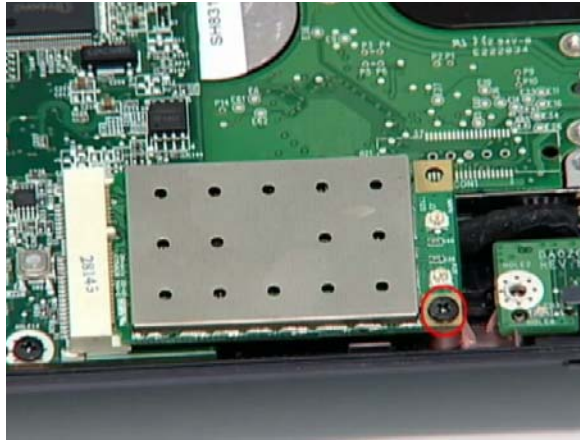
1. See "Removing the Battery Pack" on page 36.
2. Remove the securing screw as shown.



Step	Size	Quantity	Screw Type
WLAN Module	M2*3 (NL)	1	

NOTE: The antenna cables were removed during the LCD module disassembly. See "Removing the LCD Module" on page 42.

3. The module pops up. Remove it from the mainboard as shown.

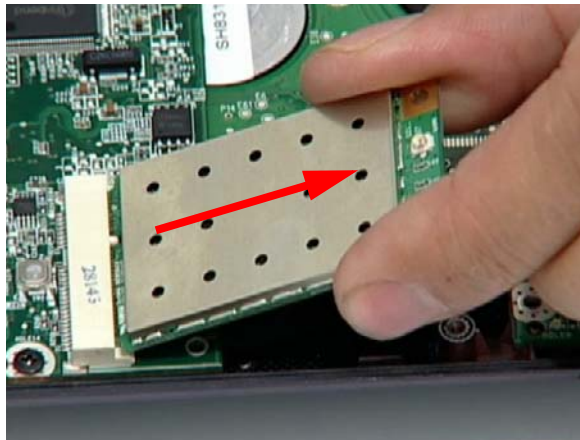

Removing the USB/LED/Power/Card Reader Board

1. Remove the upper cover. See “Removing the Upper and Lower Covers” on page 39.
2. Remove the three (3) securing screws as shown.

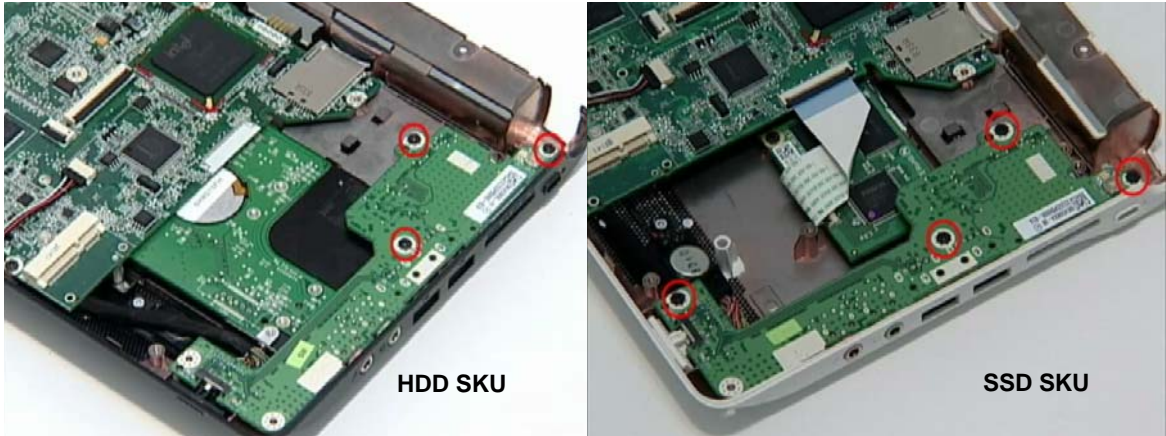

Step	Size	Quantity	Screw Type
HDD SKU: USB/LED/Power board	M2*3 (NL)	3	
SDD SKU: USB/LED/Power board	M2*3 (NL)	4	

3. Lift the board to expose the USB/LED/Power board to mainboard cable.

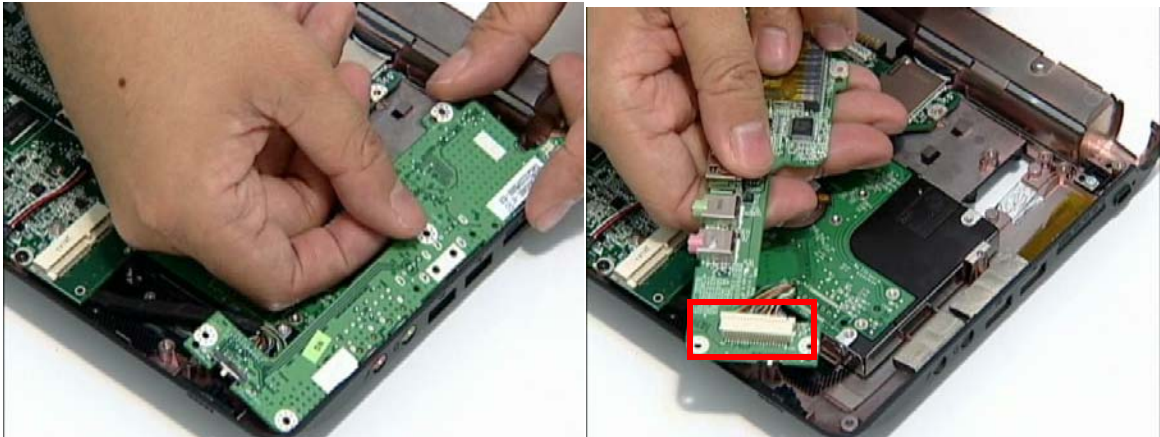

-
4. Disconnect the cable and remove the board.

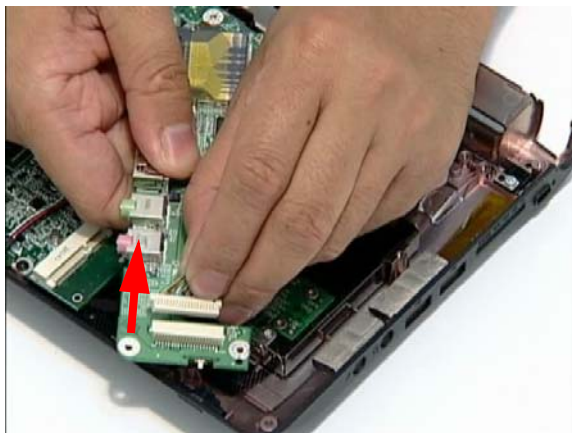

Removing the SSD Module

IMPORTANT: The SSD module is only available on the Aspire one SSD SKU.

1. Remove the mainboard. See “Removing the Mainboard” on page 55.
2. Disconnect the FFC from its connector.

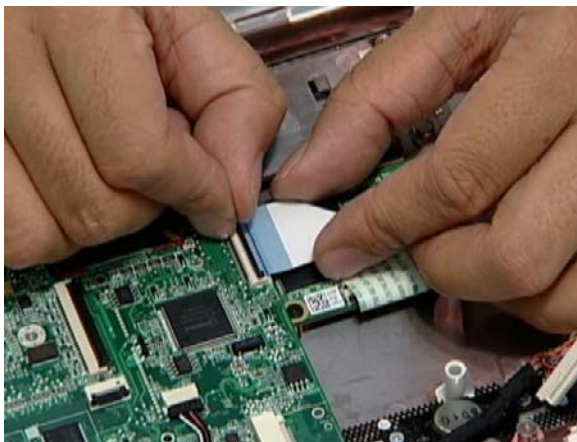



3. Disconnect the FFC cable from the module.

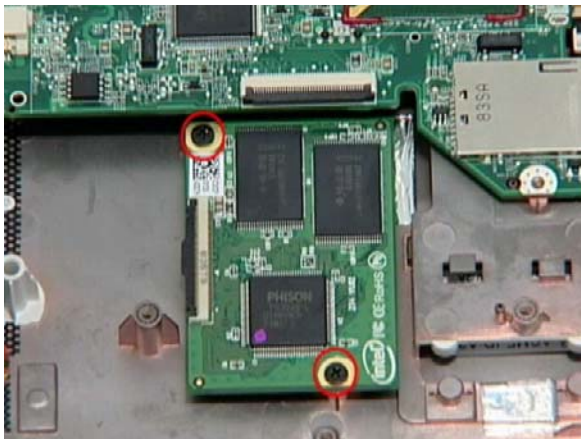

NOTE: To prevent damage to device, avoid pressing down on it or placing heavy objects on top of it.

4. Remove the two securing screws.



Step	Size	Quantity	Screw Type
SSD Module	M2*3 (NL)	2	

5. Remove the SSD module.

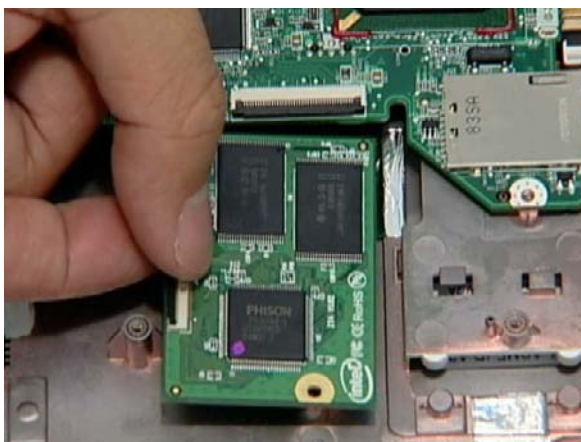

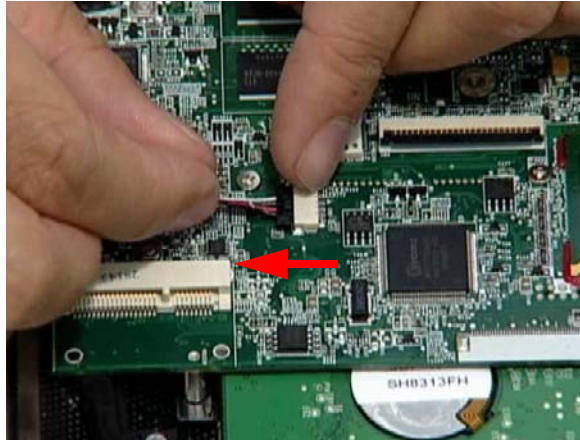

Removing the Mainboard

1. Remove the Upper Cover. See “Removing the Upper and Lower Covers” on page 39.
2. Remove the WLAN module. See “Removing the WLAN Module” on page 51.
3. Remove the USB/LED/Power/Card Reader Board. See “Removing the USB/LED/Power/Card Reader Board” on page 52.
4. Disconnect the speaker to mainboard cable.

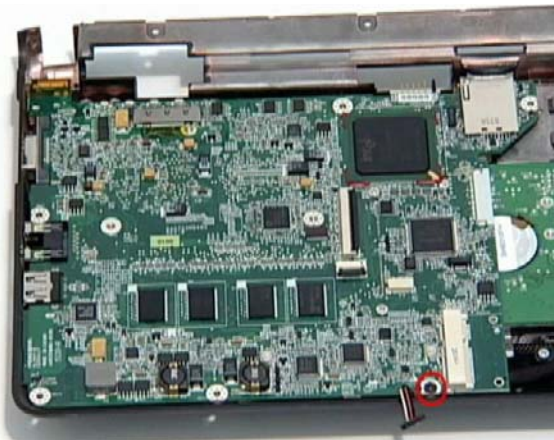

5. Remove the single securing screw.



Step	Size	Quantity	Screw Type
Mainboard	M2*3 (NL)	1	

6. Grip the mainboard and remove.

NOTE: The SSD image may differ from the following illustration.

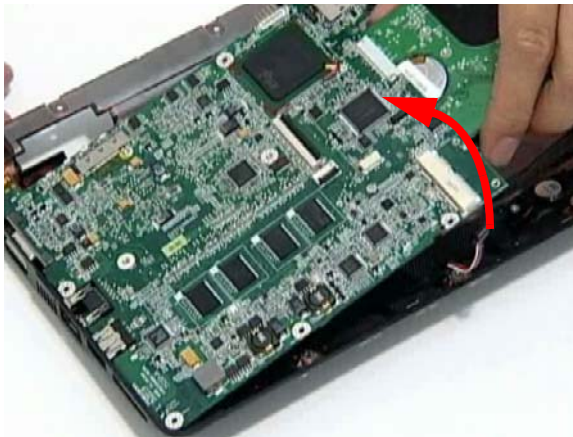

Removing the Speaker Module

1. Remove the Upper Cover. See “Removing the Upper and Lower Covers” on page 39.
2. Peel back the two adhesive strips.

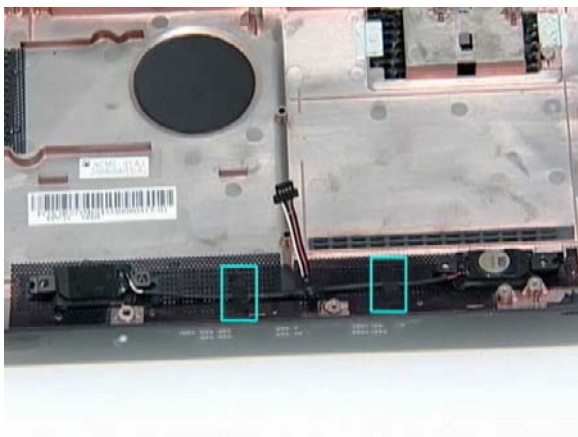

3. Remove the four (4) securing screws (2 on each side).



Step	Size	Quantity	Screw Type
Speaker Module	M2*3 (NL)	4	

4. Remove the Speaker Module from the upper cover.

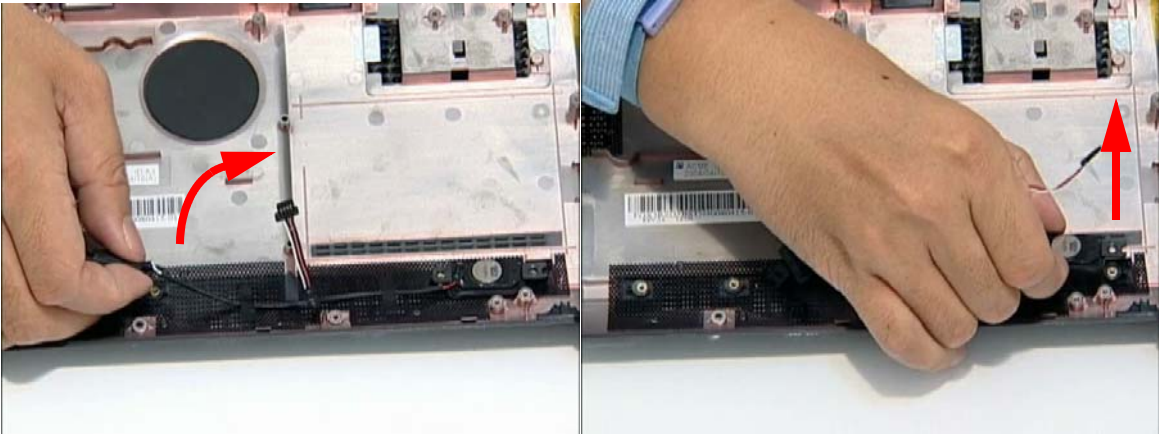

Removing the Hard Disk Drive Module

IMPORTANT: The HDD is only available on the Aspire one HDD SKU.

1. Remove the mainboard. See “Removing the Mainboard” on page 55.
2. Remove the two securing screws to release the carrier.



Step	Size	Quantity	Screw Type
HDD Module	M2.5*4 (NL)	2	

3. Hold the carrier and slide the HDD away from the mainboard.

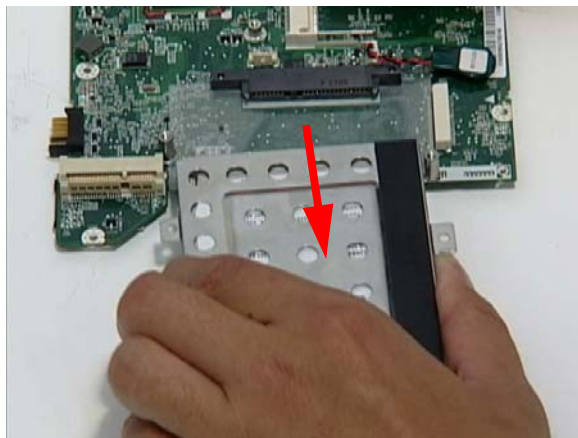

NOTE: To prevent damage to device, avoid pressing down on it or placing heavy objects on top of it.

4. Remove the four screws (two each side) securing the HDD to the carrier.

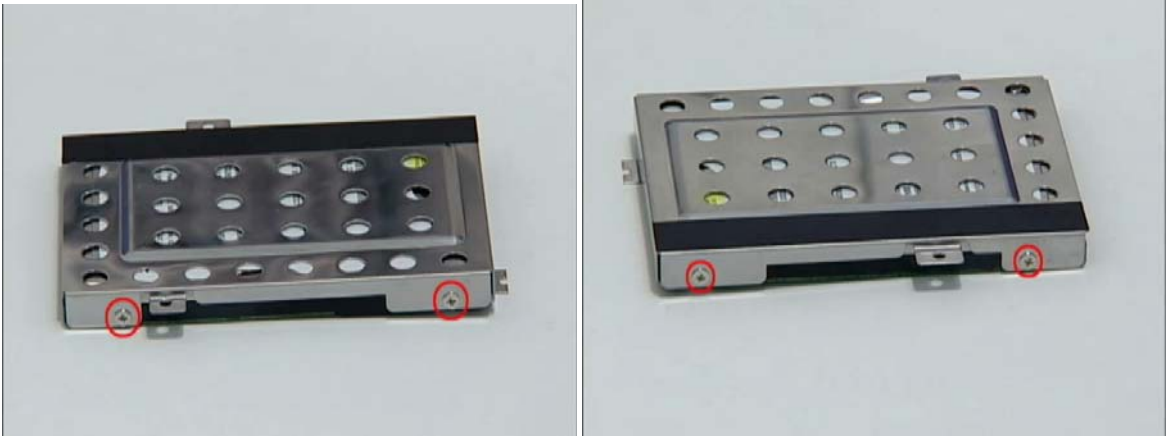

Step	Size	Quantity	Screw Type
HDD Carrier	M3*3.5 (NL)	4	

5. Turn the HDD on its side and pull the carrier away.



Removing the DIMM Module

IMPORTANT: The Aspire one SSD SKU does not come standard with DIMM modules. The modules are optional components for this SKU.

1. Remove the mainboard. See “Removing the Mainboard” on page 55.
2. Push out the release latches on both sides of the DIMM socket to release the DIMM module.

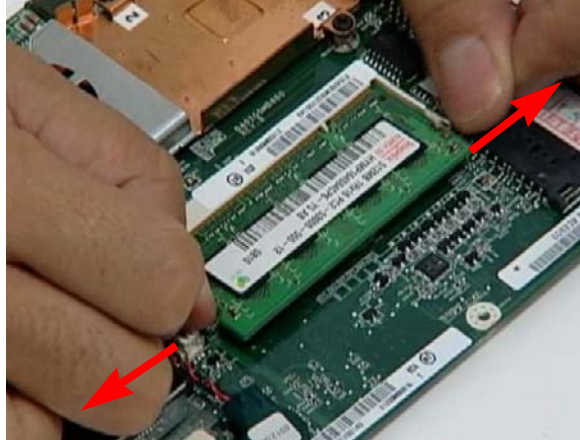

3. Remove the DIMM module.

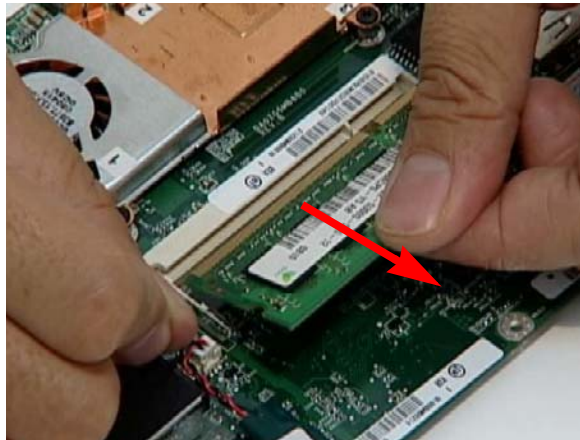

Removing the Thermal Module

1. Remove the Mainboard. See “Removing the Mainboard” on page 55.
2. Turn the Mainboard CPU side up, and place it on a clean surface.
3. Grip the cable connector and disconnect the Fan cable from the mainboard.

IMPORTANT: Do not grip the cable itself to prevent stripping.



4. Remove the three securing screws from the heatsink.

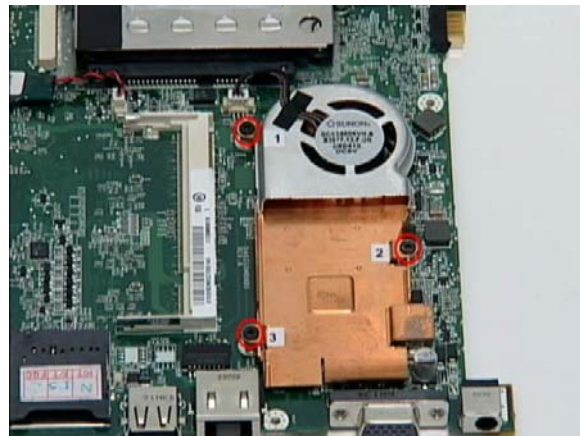

Step	Size	Quantity	Screw Type
Thermal Module	M2*3(NL)	3	

5. Remove the thermal module.



LCD Module Reassembly Procedure

Replacing the LCD Brackets and FPC Cable

1. Replace the four LCD brackets as shown.

IMPORTANT:The indicator pairs on the brackets must be located diagonally opposite each other.



2. Turn the LCD panel over and connect the FPC cable to the panel.

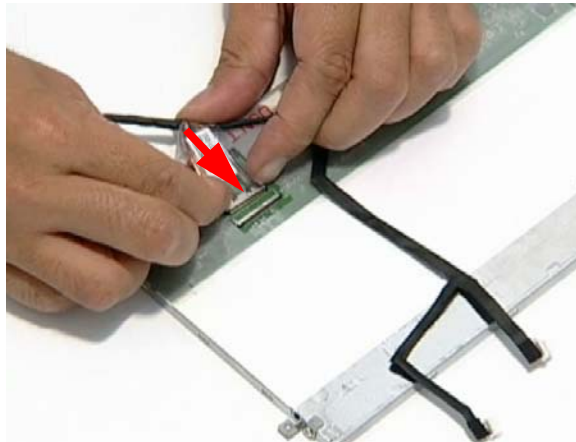

3. Secure the cable with the adhesive strips as shown.

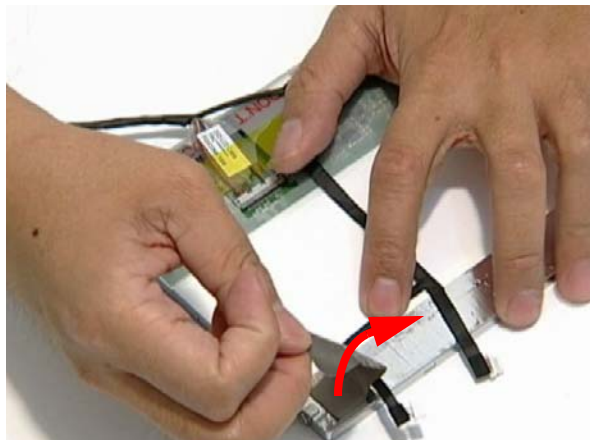
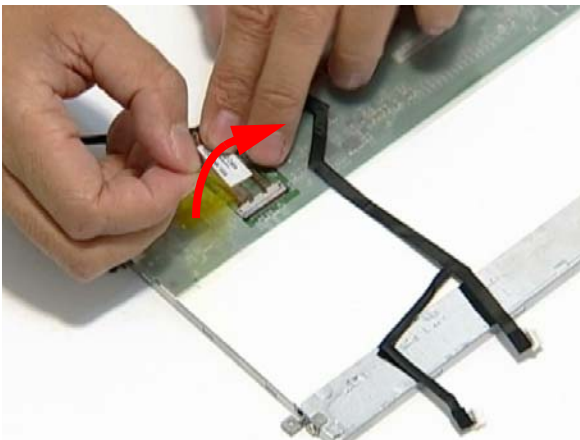

Replacing the LCD Panel

IMPORTANT: Before installing, take care of the following items:

- All cabling must be tucked tightly and close to the panel
- Check that the cables are tucked under the hinge brackets and run on the outside of the hinges

1. Place the LCD Panel in to the case as shown.

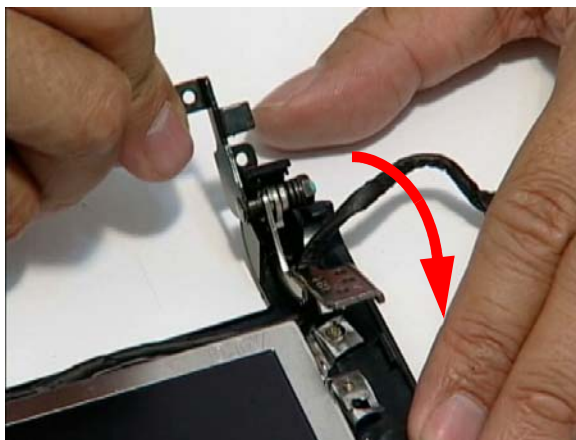

2. Replace the left hinge as shown.

3. Replace the five securing screws as shown.

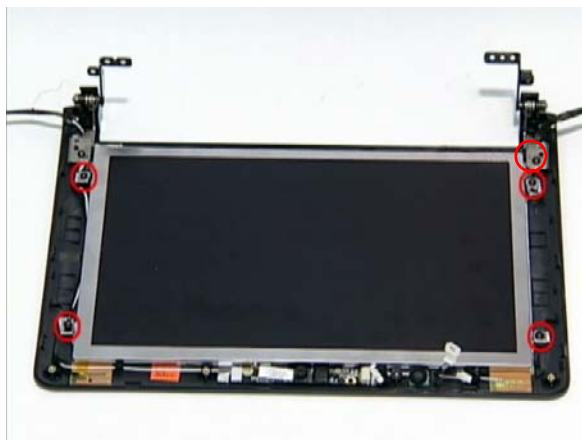

Replacing the Mic Board

1. Replace the Mic board in to the case.
2. Connect the MIC cable as shown.

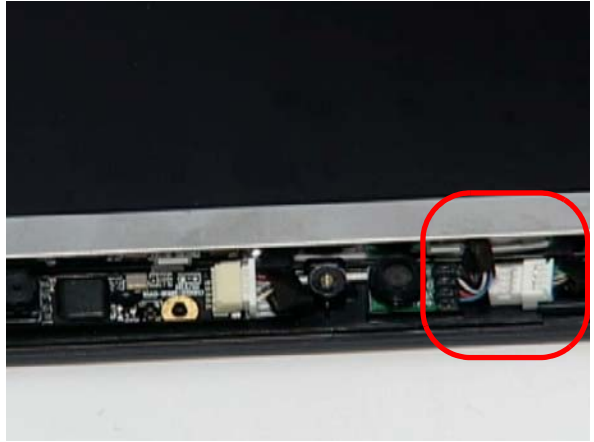

Replacing the Camera Board

1. Replace the camera board in to the case.
2. Connect the camera cable as shown.

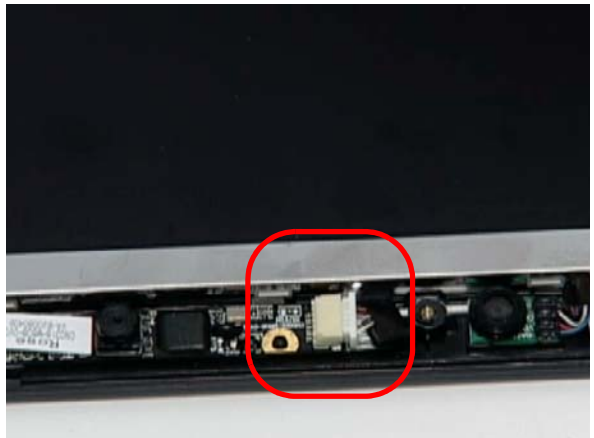
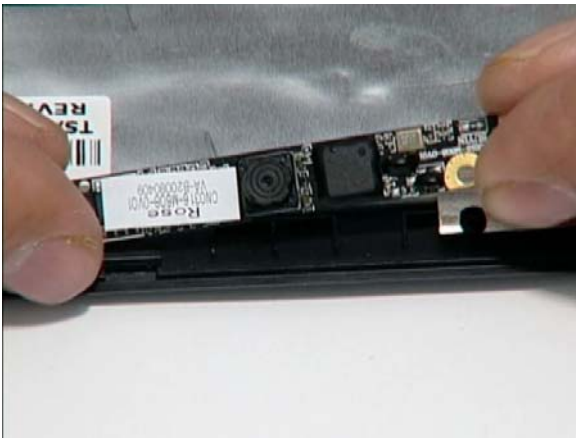

Replacing the LCD Bezel

1. Starting from the bottom, locate the bezel correctly and press down the edges until there are no gaps between the bezel and the LCD Module.

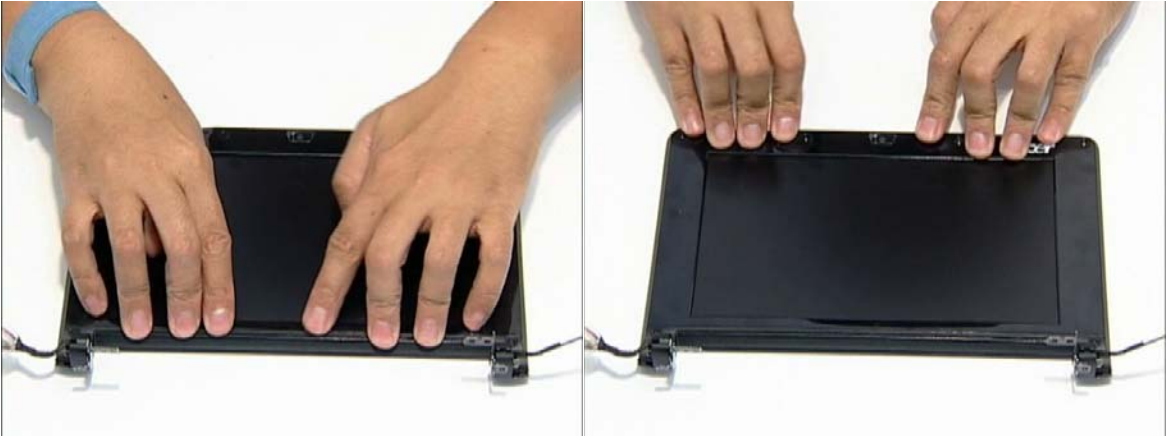

2. Replace the six screws and the rubber screw caps provided.



Main Module Reassembly Procedure

Replacing the Thermal Module

1. Replace the Fan module on the Mainboard.
2. Replace the three screws in the order shown, starting with number 1.

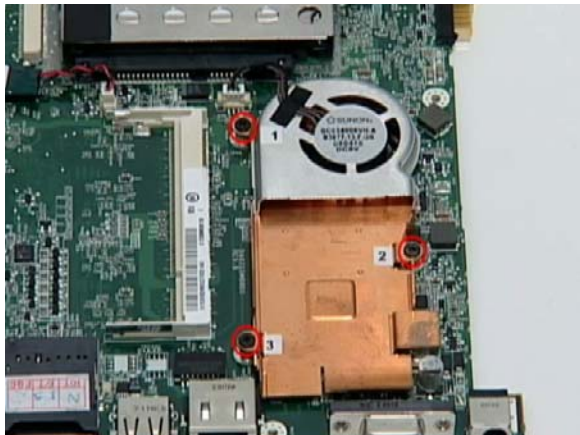

3. Connect the Fan cable to the Mainboard.



Replacing the DIMM Module

IMPORTANT:The Aspire one SSD SKU does not come standard with DIMM modules. The modules are optional components.

1. Insert DIMM1 in to the socket.
2. Press down to locate DIMM correctly.

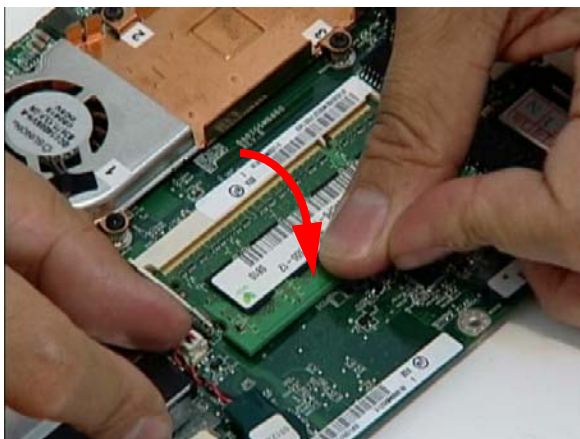
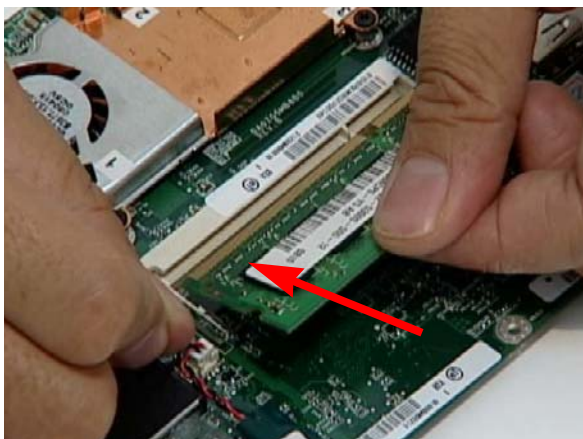

Replacing the Hard Disk Drive Module

IMPORTANT:The HDD is only available on the Aspire one HDD computer SKU.

1. Place the HDD in the HDD carrier.
2. Replace the four screws (two each side) to secure the carrier.

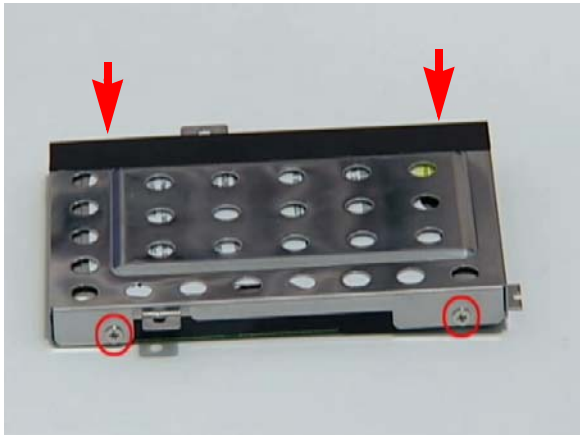

3. Hold the carrier and slide the HDD toward the mainboard until the interface connects.
4. Replace the two securing screws.

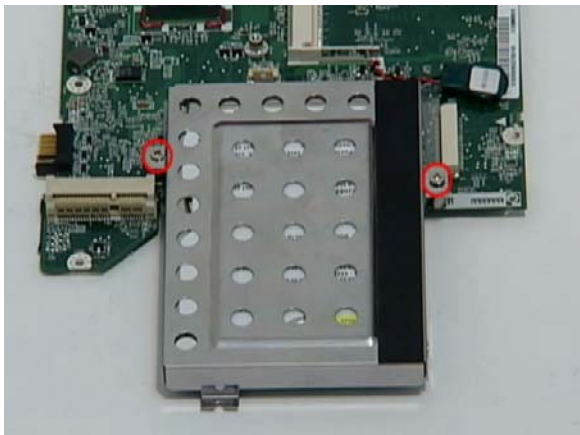
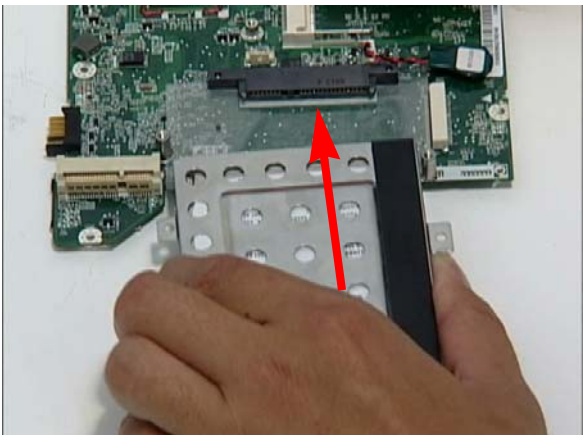

Replacing the Speaker Module

1. Replace the Speaker Module in the lower cover.
2. Replace the four securing screws.

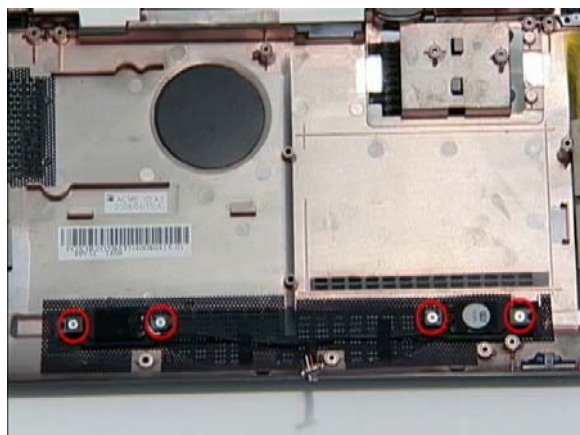
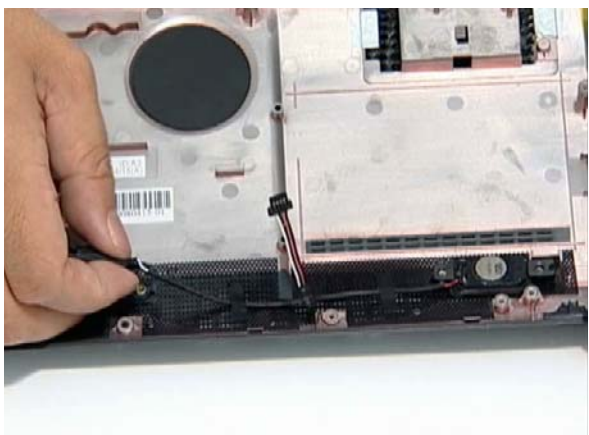

3. Replace the two adhesive strips.

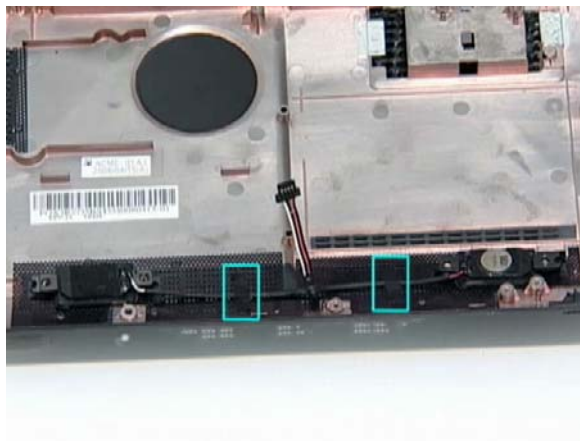

Replacing the Mainboard

IMPORTANT: Before replacing the motherboard, take care of the following items:

- Check that LED isn't broken (top of mainboard)
 - Check that the mylar next to the CPU module isn't damaged (bottom of mainboard)
 - Check the thermal power supply cable is connected properly
1. Insert the mainboard left side first into the lower cover.
 2. Replace the securing screw on the Mainboard.

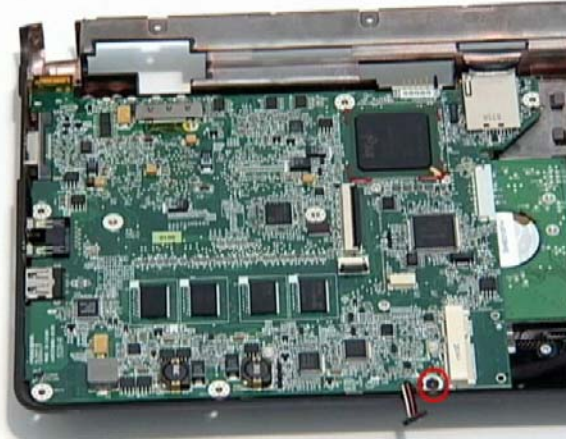
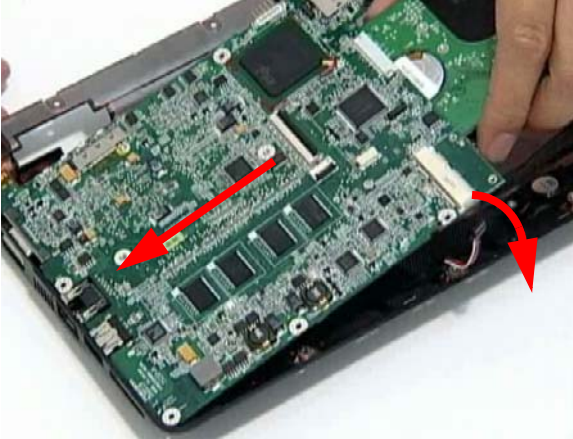

3. Connect the speaker cable to the mainboard.

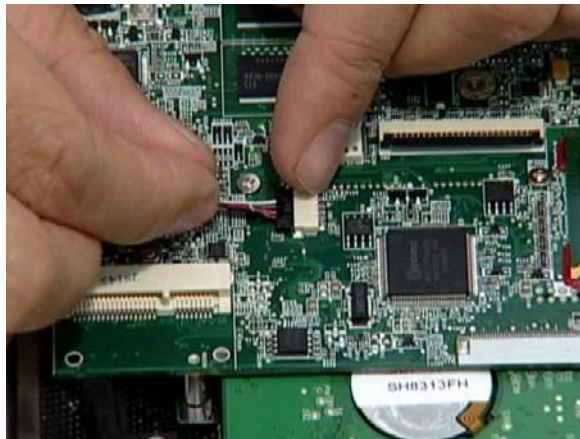

Replacing the SDD Module

IMPORTANT:The SSD module is only available on the Aspire one SSD computer SKU.

1. Place the SSD in the lower case.
2. Replace the two screws to secure the module.

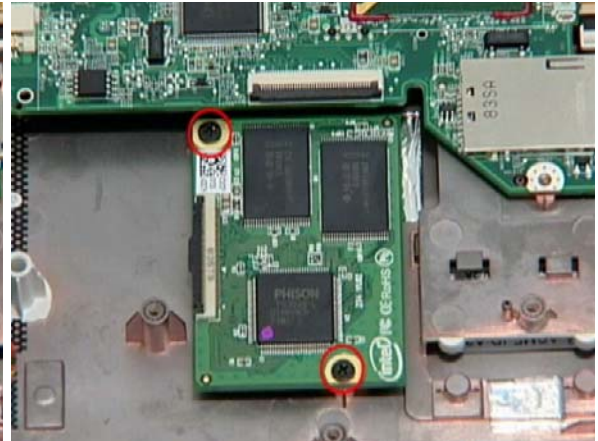
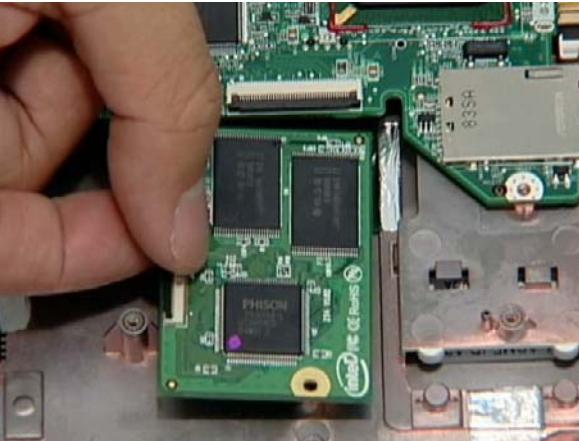

3. Connect the FFC cable to the module and close the cable latch.



4. Connect the FFC cable to the mainboard and close the cable latch.

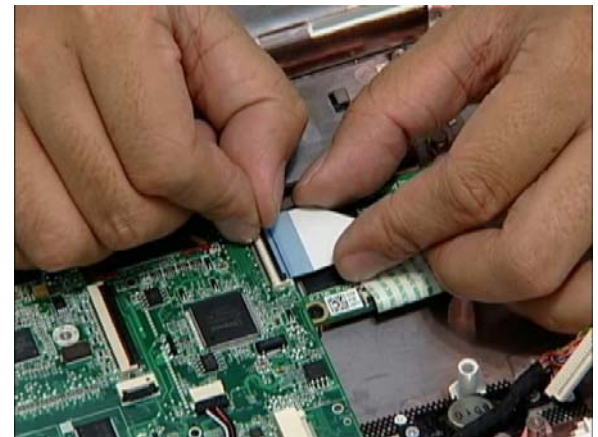

Replacing the USB/LED/Power/Card Reader Board

IMPORTANT: Before installing the USB board, take care of the following items:

- Check that LED isn't broken
- SLIDER work smoothly

1. Connect the cable to the board.

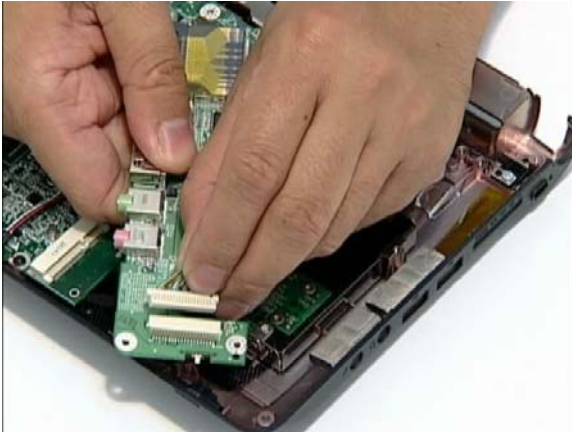

2. Turn the board over and place it in the lower case.



3. Replace the three or four screws (depending on SKU) to secure the module.



4. Connect the FFC cable to the module and close the cable latch.

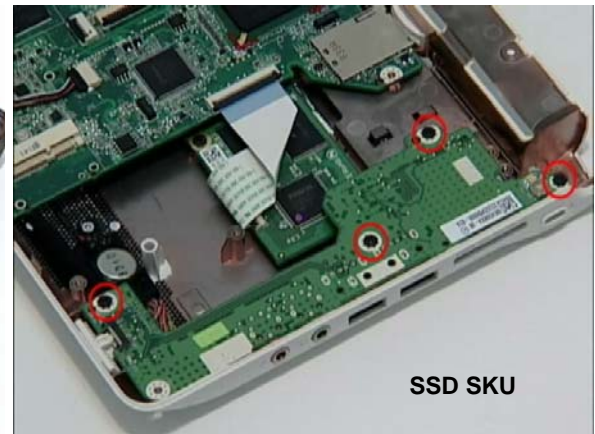

5. Connect the FFC cable to the mainboard and close the cable latch.

Replacing the WLAN Board

1. Insert the WLAN board in to the socket.
2. Push the board down and replace the securing screw.

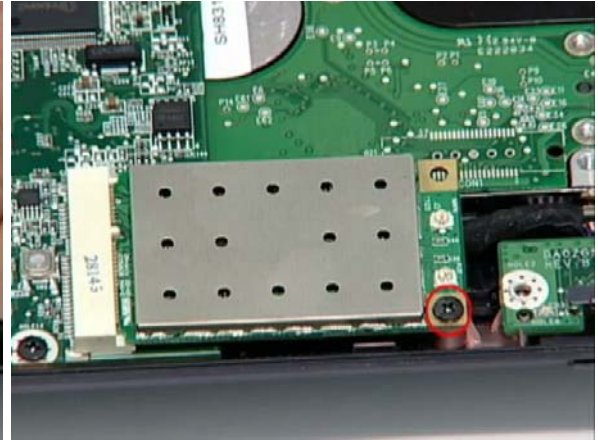
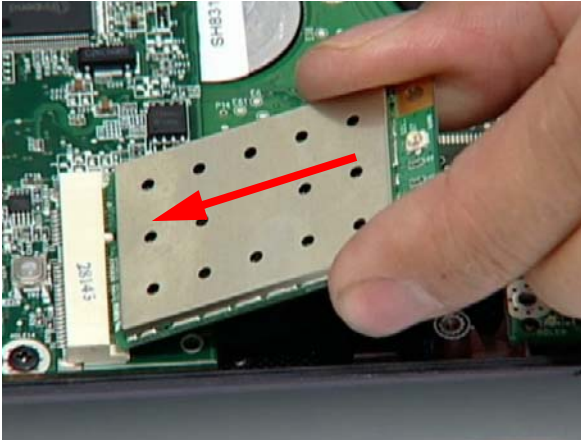

Replacing the LCM Module

1. Place the LCM module on to the lower cover at a 90 degree angle.

IMPORTANT: Ensure all cables are clear of the hinges before replacing the LCM module.

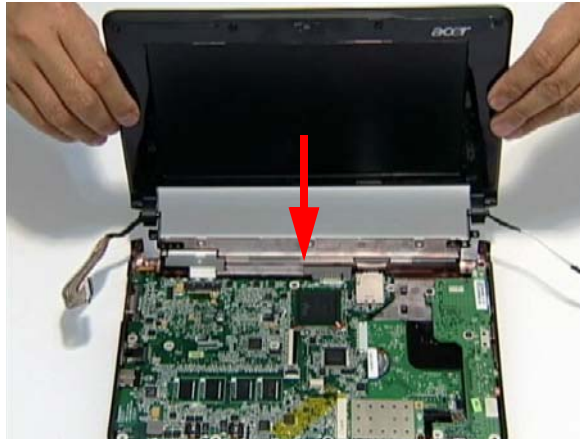

2. Replace the four screws (two each side) to secure the LCM module to the lower cover.



3. Replace the antenna cables in the housing well, as shown.



4. Replace the two antenna cables.

NOTE: The following is the correct cable-color to connector designation: Black to MAIN (left) and White to AUX (right).

5. Connect the LCD cable to the mainboard.

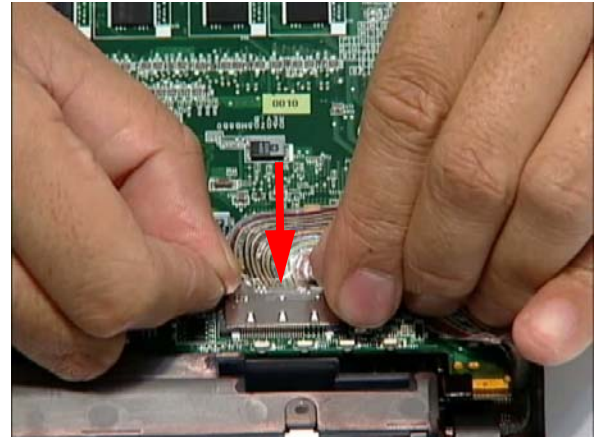
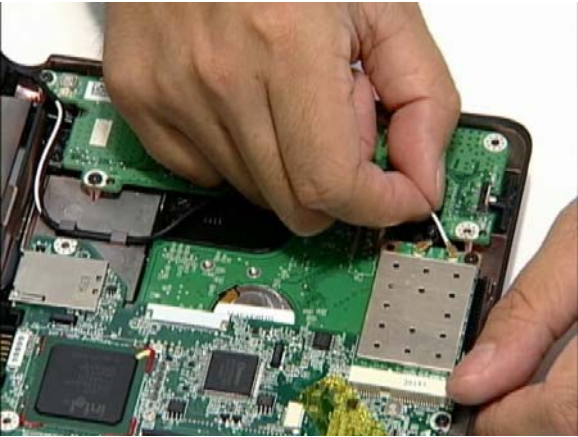

Replacing the Upper Cover

IMPORTANT: While replacing the upper cover, take note of the following items:

- Check that the mainboard is tucked underneath the housing wells in the lower cover
 - Check that the speaker cable is attached
 - Check that the antenna cables are tucked inside the housing well and do not interfere with the card reader
 - Antenna cables must be secured to the chassis walls with the provided gasket tape
 - Antenna cable on the right side must pass through the right side of hinge block
 - Make sure that the 40-PIN Cable doesn't interfere with the speaker module
1. Place the upper cover over the lower base, hinge side first.
 2. Set the Upper Cover down on the lower base and press down as shown.

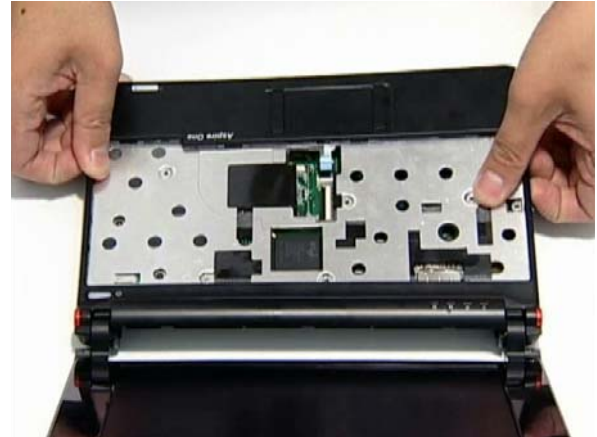
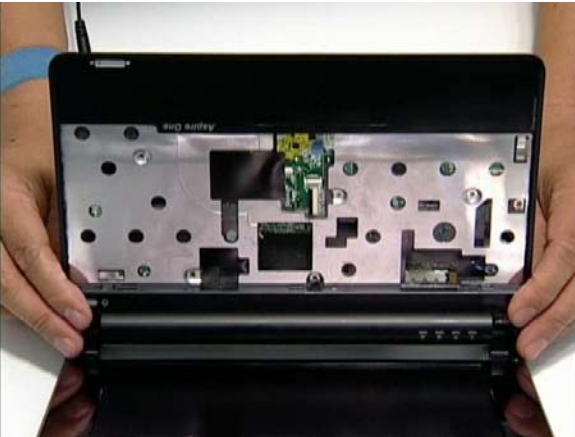

3. Replace the five securing screws on the Upper Cover.

4. Reconnect the touchpad FCC cable and close the cable latch.

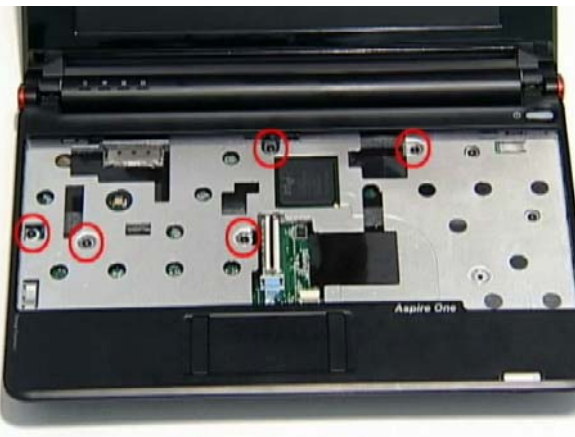

5. Turn the computer upside down and replace the eight securing screws on the bottom panel to attach the upper and lower covers.



6. Replace the two rubber foot pads.

Replacing the Keyboard

1. Replace keyboard cable to the mainboard, and secure the locking latch.
2. Turn the keyboard over and place the front edge first in the mounting.

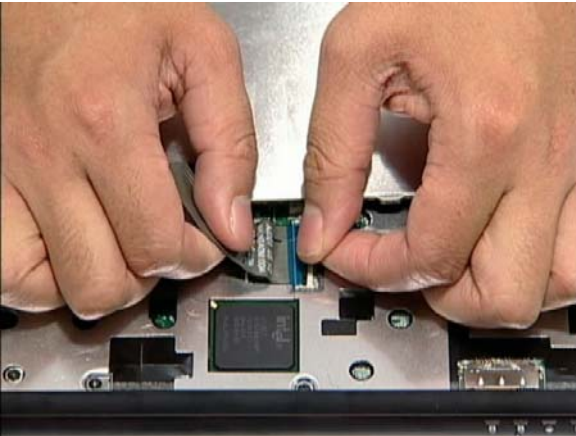

3. Press down on the areas shown below to secure in place.



Replacing the 3G cover

1. Replace the 3G cover.
2. Secure the two captive screws.



Replacing the Battery

1. Slide and hold the battery release latch (1), insert battery in to the main unit (2).
2. Slide the battery lock/unlock latch to the lock position.



Troubleshooting

Common Problems

Use the following procedure as a guide for computer problems.

NOTE: The diagnostic tests are intended to test only Acer products. Non-Acer products, prototype cards, or modified options can give false errors and invalid system responses.

1. Obtain the failing symptoms in as much detail as possible.
2. Verify the symptoms by attempting to re-create the failure by running the diagnostic test or by repeating the same operation.
3. Use the following table with the verified symptom to determine which page to go to.

Symptoms (Verified)	Go To
Power On Issue	Page 80
No Display Issue	Page 81
LCD Failure	Page 84
Internal Keyboard Failure	Page 84
TouchPad Failure	Page 85
Internal Speaker Failure	Page 85
Internal Microphone Failure	Page 87
Rightside USB Failure	Page 89
Power Button Failure	Page 89
Other Functions Failure	Page 90
Intermittent Failures	Page 91
Undermined Failures	Page 91

4. If the Issue is still not resolved, see "Online Support Information" on page 161.

Power On Issue

If the system doesn't power on, perform the following actions one at a time to correct the problem. Do not replace a non-defective FRUs:

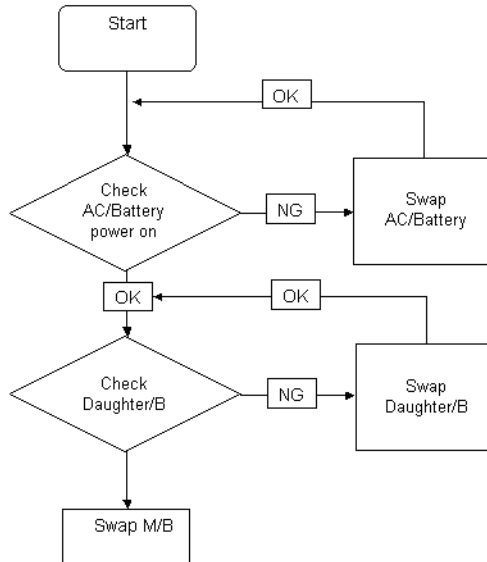

Computer Shutdown Intermittently

If the system powers off at intervals, perform the following actions one at a time to correct the problem.

1. Check the power cable is properly connected to the computer and the electrical outlet.
2. Remove any extension cables between the computer and the outlet.
3. Remove any surge protectors between the computer and the electrical outlet. Plug the computer directly into a known good electrical outlet.
4. Remove all external and non-essential hardware connected to the computer that are not necessary to boot the computer to the failure point.
5. Remove any recently installed software.
6. If the Issue is still not resolved, see "Online Support Information" on page 161.

No Display Issue

If the **Display** doesn't work, perform the following actions one at a time to correct the problem. Do not replace a non-defective FRUs:

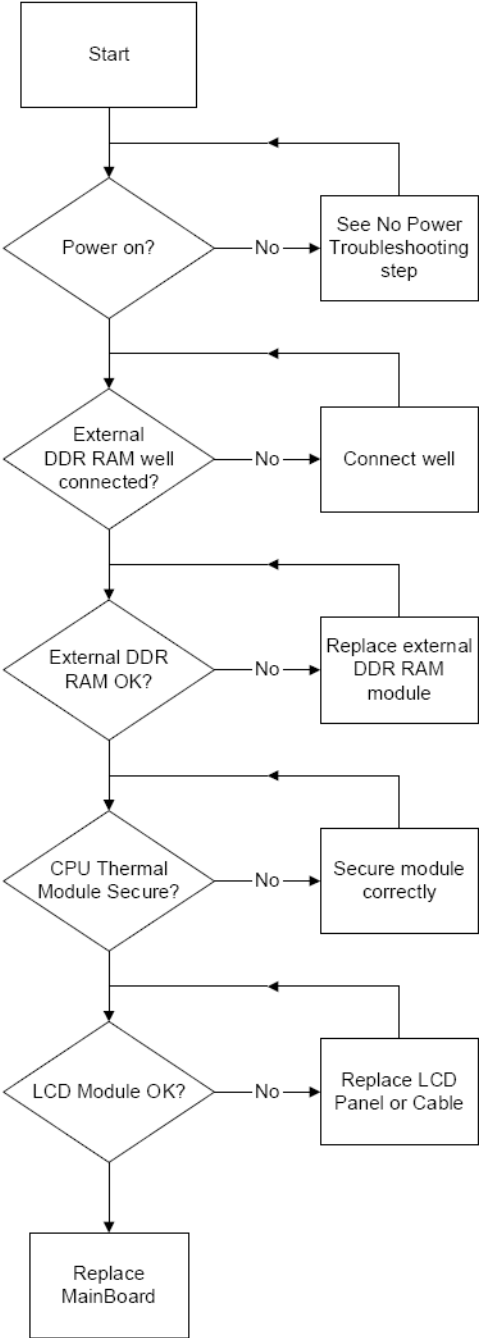

No POST or Video

If the POST or video doesn't display, perform the following actions one at a time to correct the problem.

1. Make sure that the internal display is selected. On this notebook model, switching between the internal display and the external display is done by pressing **Fn+F5**. Reference Product pages for specific model procedures.
2. Make sure the computer has power by checking at least one of the following occurs:
 - Fans start up
 - Status LEDs light up

If there is no power, see "Power On Issue" on page 80.

3. Drain any stored power by removing the power cable and battery and holding down the power button for 10 seconds. Reconnect the power and reboot the computer.
4. Connect an external monitor to the computer and switch between the internal display and the external display is by pressing **Fn+F5** (on this model).

If the POST or video appears on the external display, see "LCD Failure" on page 84.

5. Disconnect power and all external devices including port replicators or docking stations. Remove any memory cards and CD/DVD discs. Restart the computer.

If the computer boots correctly, add the devices one by one until the failure point is discovered.

6. Reseat the memory modules.
7. Remove the drives (see "Disassembly Process" on page 34).
8. If the Issue is still not resolved, see "Online Support Information" on page 161.

Abnormal Video Display

If video displays abnormally, perform the following actions one at a time to correct the problem.

1. Reboot the computer.
2. If permanent vertical/horizontal lines or dark spots display in the same location, the LCD is faulty and should be replaced. See “Disassembly Process” on page 34.
3. If extensive pixel damage is present (different colored spots in the same locations on the screen), the LCD is faulty and should be replaced. See “Disassembly Process” on page 34.
4. Adjust the brightness to its highest level. See the User Manual for instructions on adjusting settings.
NOTE: Ensure that the computer is not running on battery alone as this may reduce display brightness.
If the display is too dim at the highest brightness setting, the LCD is faulty and should be replaced. See “Disassembly Process” on page 34.
5. Check the display resolution is correctly configured:
 - a. Minimize or close all Windows.
 - b. If display size is only abnormal in an application, check the view settings and control/mouse wheel zoom feature in the application.
 - c. If desktop display resolution is not normal, right-click on the desktop and select **Personalize**→ **Display Settings**.
 - d. Click and drag the Resolution slider to the desired resolution.
 - e. Click **Apply** and check the display. Readjust if necessary.
6. Roll back the video driver to the previous version if updated.
7. Remove and reinstall the video driver.
8. Check the Device Manager to determine that:
 - The device is properly installed. There are no red Xs or yellow exclamation marks.
 - There are no device conflicts.
 - No hardware is listed under Other Devices.
9. If the Issue is still not resolved, see “Online Support Information” on page 161.
10. Run the Windows Memory Diagnostic from the operating system DVD and follow the onscreen prompts.
11. If the Issue is still not resolved, see “Online Support Information” on page 161.

Random Loss of BIOS Settings

If the computer is experiencing intermittent loss of BIOS information, perform the following actions one at a time to correct the problem.

1. If the computer is more than one year old, replace the CMOS battery.
2. Run a complete virus scan using up-to-date software to ensure the computer is virus free.
3. If the computer is experiencing HDD or ODD BIOS information loss, disconnect and reconnect the power and data cables between devices.
If the BIOS settings are still lost, replace the cables.
4. If HDD information is missing from the BIOS, the drive may be defective and should be replaced.
5. Replace the Motherboard.
6. If the Issue is still not resolved, see “Online Support Information” on page 161.

LCD Failure

If the **LCD** fails, perform the following actions one at a time to correct the problem. Do not replace a non-defective FRUs:

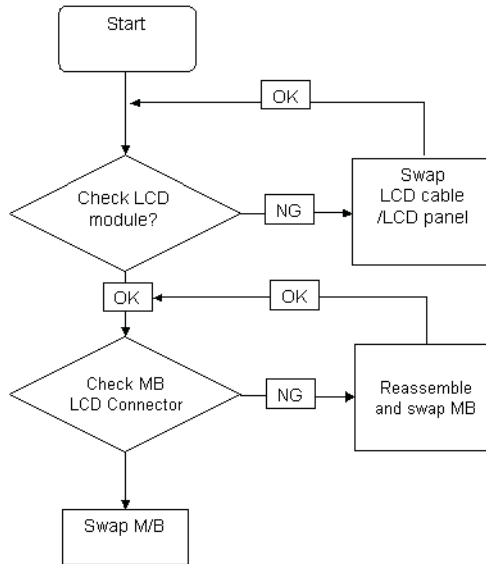

Built-In Keyboard Failure

If the built-in **Keyboard** fails, perform the following actions one at a time to correct the problem. Do not replace a non-defective FRUs:

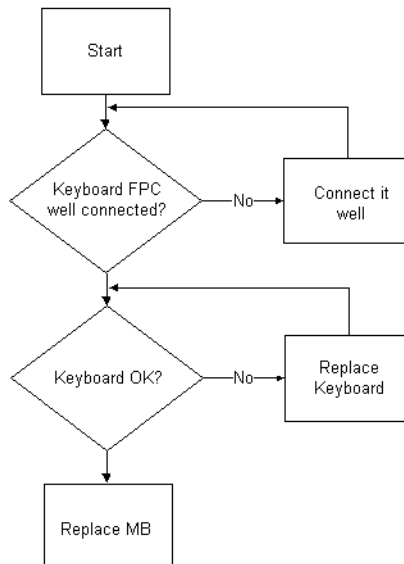

TouchPad Failure

If the **TouchPad** doesn't work, perform the following actions one at a time to correct the problem. Do not replace a non-defective FRUs:

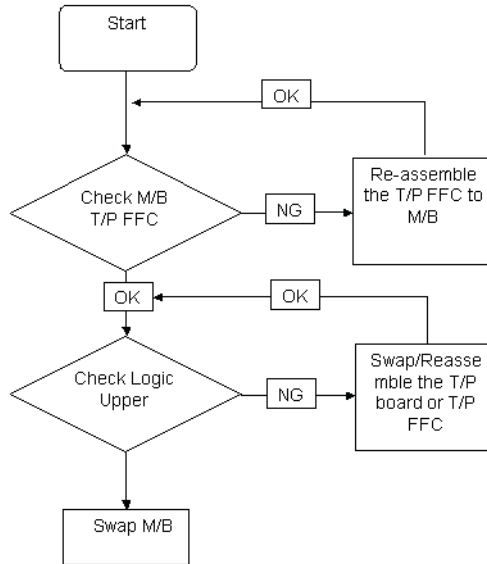

Internal Speaker Failure

If the internal **Speakers** fail, perform the following actions one at a time to correct the problem. Do not replace a non-defective FRUs:

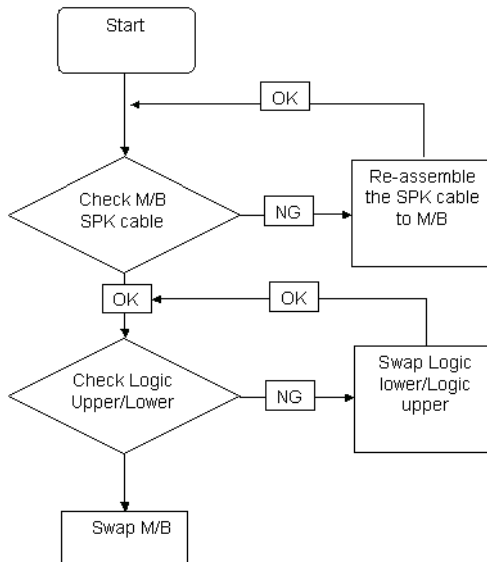

Sound Problems

If sound problems are experienced, perform the following actions one at a time to correct the problem.

1. Reboot the computer.
2. Navigate to **Start** → **Control Panel** → **System and Maintenance** → **System** → **Device Manager**. Check the Device Manager to determine that:

-
- The device is properly installed.
 - There are no red Xs or yellow exclamation marks.
 - There are no device conflicts.
 - No hardware is listed under Other Devices.
3. Roll back the audio driver to the previous version, if updated recently.
 4. Remove and reinstall the audio driver.
 5. Ensure that all volume controls are set mid range:
 - a. Click the volume icon on the taskbar and drag the slider to 50. Ensure that the volume is not muted.
 - b. Click Mixer to verify that other audio applications are set to 50 and not muted.
 6. Navigate to **Start** → **Control Panel** → **Hardware and Sound** → **Sound**. Ensure that Speakers are selected as the default audio device (green check mark).

NOTE: If Speakers does not show, right-click on the **Playback** tab and select **Show Disabled Devices** (clear by default).
 7. Select Speakers and click **Configure** to start **Speaker Setup**. Follow the onscreen prompts to configure the speakers.
 8. Remove and recently installed hardware or software.
 9. Restore system and file settings from a known good date using **System Restore**.

If the issue is not fixed, repeat the preceding steps and select an earlier time and date.
 10. Reinstall the Operating System.
 11. If the Issue is still not resolved, see “Online Support Information” on page 161.

Internal Microphone Failure

If the internal **Microphone** fails, perform the following actions one at a time to correct the problem. Do not replace a non-defective FRUs:

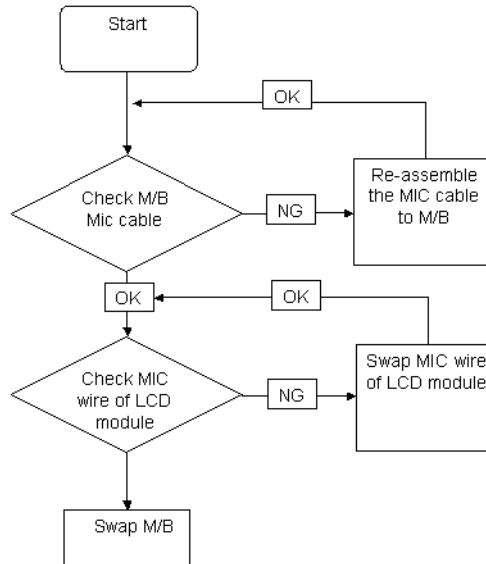

Microphone Problems

If internal or external **Microphones** do not operate correctly, perform the following actions one at a time to correct the problem.

1. Check that the microphone is enabled. Navigate to **Start** → **Control Panel** → **Hardware and Sound** → **Sound** and select the **Recording** tab.
2. Right-click on the **Recording** tab and select **Show Disabled Devices** (clear by default).
3. The microphone appears on the **Recording** tab.
4. Right-click on the microphone and select **Enable**.
5. Select the microphone then click **Properties**. Select the **Levels** tab.
6. Increase the volume to the maximum setting and click **OK**.
7. Test the microphone hardware:
 - a. Select the microphone and click **Configure**.
 - b. Select **Set up microphone**.
 - c. Select the microphone type from the list and click **Next**.
 - d. Follow the onscreen prompts to complete the test.
8. If the Issue is still not resolved, see "Online Support Information" on page 161.

HDD Not Operating Correctly

If the **HDD** does not operate correctly, perform the following actions one at a time to correct the problem.

1. Disconnect all external devices.
2. Run a complete virus scan using up-to-date software to ensure the computer is virus free.
3. Run the Windows Vista Startup Repair Utility:
 - a. insert the Windows Vista Operating System DVD in the ODD and restart the computer.
 - b. When prompted, press any key to start to the operating system DVD.
 - c. The **Install Windows** screen displays. Click **Next**.
 - d. Select **Repair your computer**.
 - e. The **System Recovery Options** screen displays. Click **Next**.
 - f. Select the appropriate operating system, and click **Next**.

NOTE: Click **Load Drivers** if controller drives are required.

- g. Select **Startup Repair**.
- h. Startup Repair attempts to locate and resolve issues with the computer.
- i. When complete, click **Finish**.

If an issue is discovered, follow the onscreen information to resolve the problem.

4. Run the Windows Memory Diagnostic Tool. For more information see Windows Help and Support.
5. Restart the computer and press F2 to enter the BIOS Utility. Check the BIOS settings are correct and that CD/DVD drive is set as the first boot device on the Boot menu.
6. Ensure all cables and jumpers on the HDD and ODD are set correctly.
7. Remove any recently added hardware and associated software.
8. Run the Windows Disk Defragmenter. For more information see Windows Help and Support.
9. Run Windows Check Disk by entering **chkdsk /r** from a command prompt. For more information see Windows Help and Support.
10. Restore system and file settings from a known good date using **System Restore**.

If the issue is not fixed, repeat the preceding steps and select an earlier time and date.
11. Replace the HDD. See "Disassembly Process" on page 34.

USB Failure (Rightside)

If the rightside **USB** port fails, perform the following actions one at a time to correct the problem. Do not replace a non-defective FRUs:

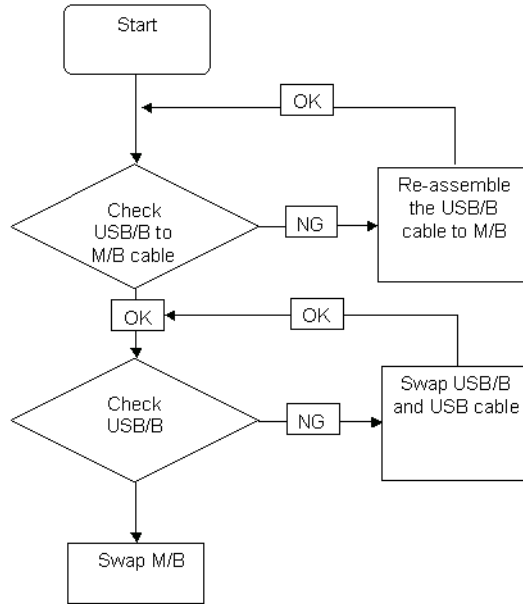

Power Button Failure

If the Power Button fails, perform the following actions one at a time to correct the problem. Do not replace a non-defective FRUs:

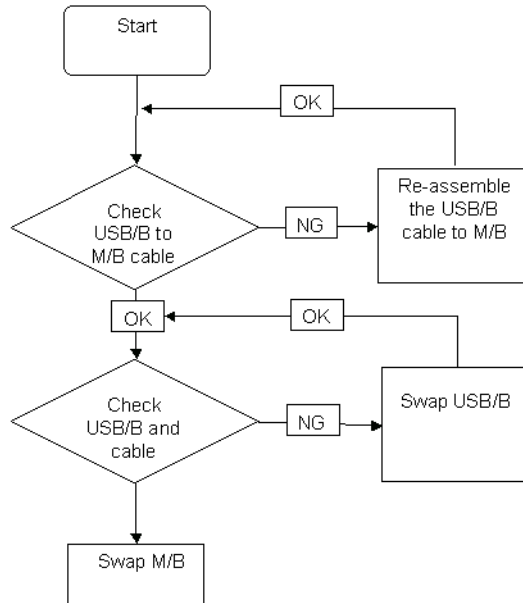

External Mouse Failure

If an external **Mouse** fails, perform the following actions one at a time to correct the problem.

1. Try an alternative mouse.
2. If the mouse uses a wireless connection, insert new batteries and confirm there is a good connection. See the mouse user manual.
3. If the mouse uses a USB connection, try an alternate USB port.
4. Try an alternative program to verify mouse operation. Reinstall the program experiencing mouse failure.
5. Restart the computer.
6. Remove any recently added hardware and associated software.
7. Remove any recently added software and reboot.
8. Restore system and file settings from a known good date using **System Restore**.

If the issue is not fixed, repeat the preceding steps and select an earlier time and date.

9. Run the Event Viewer to check the events log for errors. For more information see Windows Help and Support.
10. Roll back the mouse driver to the previous version if updated recently.
11. Remove and reinstall the mouse driver.
12. Check the Device Manager to determine that:
 - The device is properly installed. There are no red Xs or yellow exclamation marks.
 - There are no device conflicts.
 - No hardware is listed under Other Devices.
13. If the Issue is still not resolved, see "Online Support Information" on page 161.

Other Failures

If the CRT Switch, Dock, LAN Port, external MIC or Speakers, PCI Express Card, 5-in-1 Card Reader or Volume Wheel fail, perform the following general steps to correct the problem. Do not replace a non-defective FRUs:

1. Check Drive whether is OK.
2. Check Test Fixture is ok.
3. Swap M/B to Try.

Intermittent Problems

Intermittent system hang problems can be caused by a variety of reasons that have nothing to do with a hardware defect, such as: cosmic radiation, electrostatic discharge, or software errors. FRU replacement should be considered only when a recurring problem exists.

When analyzing an intermittent problem, do the following:

1. Run the advanced diagnostic test for the system board in loop mode at least 10 times.
2. If no error is detected, do not replace any FRU.
3. If any error is detected, replace the FRU. Rerun the test to verify that there are no more errors.

Undetermined Problems

The diagnostic problems does not identify which adapter or device failed, which installed devices are incorrect, whether a short circuit is suspected, or whether the system is inoperative.

Follow these procedures to isolate the failing FRU (do not isolate non-defective FRU).

NOTE: Verify that all attached devices are supported by the computer.

NOTE: Verify that the power supply being used at the time of the failure is operating correctly. (See “Power On Issue” on page 80):

1. Power-off the computer.
2. Visually check them for damage. If any problems are found, replace the FRU.
3. Remove or disconnect all of the following devices:
 - Non-Acer devices
 - Printer, mouse, and other external devices
 - Battery pack
 - Hard disk drive
 - DIMM
 - CD-ROM/Diskette drive Module
 - PC Cards
4. Power-on the computer.
5. Determine if the problem has changed.
6. If the problem does not recur, reconnect the removed devices one at a time until you find the failing FRU.
7. If the problem remains, replace the following FRU one at a time. Do not replace a non-defective FRU:
 - System board
 - LCD assembly

Frequently Asked Questions (FAQ)

This section provides help in the form of questions and answers for commonly encountered troubleshooting issues.

If the system encountered problem, where can I get assistance?

When you encounter any problem, we recommend you perform the following steps in the order listed:

1. Please read the Quick Guide
 - When you encounter usage problems, we strongly recommend you to read the Quick Guide for reference. See “How can I browse the Aspire one Quick Guide?” on page 94.
2. Reference the Linpus FAQ webpage
 - The Linpus FAQ webpage (<http://www.linpus.com/xampp/modules/smartfaq/>) periodically updates the FAQ from user and community experience; users can visit the web site to search for help.
3. Email Linpus Helpdesk Support
 - You can write an email to helpdesk@linpus.com, where dedicated support staff are on hand to serve you.

What peripheral equipment is supported by Acer Aspire one?

In addition to supporting the onboard peripheral devices, Acer Aspire one also provides full support for USB interface devices such as USB drive, external CD/DVD-ROM, external Hard drives etc. The built-in multi card-reader supports SD/MMS/MS-PRO/xD, and in future, **Live-update** will also incorporate system upgrade support for SDHC/SD2.0.

If I want to expand the memory and storage capacity of my Acer Aspire one, how can I do so?

Acer Aspire one allows the user to expand the memory using the expansion slot on the base of the machine. Please refer to the system specifications to obtain related information on suitable memory models. The internal storage device of Acer Aspire one does not support expansion.

Can Acer Aspire one handle my original files stored in Windows formats?

Acer Aspire one has equivalent applications to handle most file formats from the Windows environment. For example, Microsoft Office formats such as .doc, .xls, and .ppt, can be edited and stored using OpenOffice.org. For graphic, audio, video, email and other formats, Acer Aspire one provides Linux applications for processing. The following table lists Windows applications and their Linux equivalents:

Windows Application/File Format	Linux Alternative Solution
Word	OpenOffice Writer 2.3
Excel	OpenOffice Impress 2.3
PowerPoint	OpenOffice Presentation 2.3
Image processing applications	KolourPaint, Photo Master
Acrobat Reader	Acrobat Reader for Linux 8.1.2
MP3 and other audio files	Media Master
Internet Explorer	Firefox 2.0.0.14
Videos	Media Master
Audio CD Playback	Media Master
MSN/ICQ/QQ	Acer Aspire one Messenger 1.01.2012

Can the Acer Aspire one Messenger communicate with MSN, Yahoo Messenger, Google Talk and other live communication tools?

Yes. The Acer Aspire one Messenger allows users to login to MSN, Yahoo Messenger, Google Talk, AIM and so on.

If I want to preserve my Messenger Communication record, how can I do so?

Open the Aspire one Messenger Communication software and in the menu bar, select **Tools** and then **Messages**. Check the **Automatically keep a history of each conversation** box to record all conversation history.

How does Acer Aspire one perform System Recovery?

Each Acer Aspire one is bundled with a system recovery CD during shipping. At any time, users can restore the machine to the initial factory settings. The user must configure the BIOS to boot from USB CD-ROM (See "Boot" on page 25 of Chapter 2 System Utilities) and place the system recovery CD in the USB CD/DVD-ROM. During system startup, follow the onscreen instructions to recovery the system.

Does Acer Aspire one support other Linux applications?

Basically, the answer is yes. We strongly recommend, however, that **Live Update** is used to download Acer certified packages.

Which languages does Acer Aspire one support?

Acer Aspire one employs Unicode and therefore users can set the display language to English, Japanese, German, French, Italian, Spanish, Portuguese, Dutch, Brazilian Portuguese, Russian, Arabic, Turkish, Vietnamese, Thai etc.

During installation, the user selects the desired language and the system installs the selected Operating System language.

How many input methods does the Linpus Linux Lite support?

Other than English, Japanese, German, French, Italian, Spanish, Portuguese, Dutch, Brazilian Portuguese, and Russian, Linpus Linux Lite also provides several input modes for Traditional and Simplified Chinese (for example: ZhuYin, Cangjie, Array30, EZ-Big, Wubi). However, only the Traditional and Simplified Chinese versions of Linpus Linux Lite supports this function.



How can I remove redundant input methods?

Only the Traditional and Simplified Chinese versions of Linpus Linux Lite support this function.

How can I add more input methods?

Only the Traditional and Simplified Chinese versions of Linpus Linux Lite support this function.

How can I select or switch input modes from my keyboard?

Only the Traditional and Simplified Chinese versions of Linpus Linux Lite support this function.

Can I setup Hotkeys myself?

Only the Traditional and Simplified Chinese versions of Linpus Linux Lite support this function.

What is the Kernel version for Linpus Linux Lite?

The current version is **2.6.23.91w** but users can update the kernel using the Online-update function.

How can I adjust the monitor's DPI (dots per inch)?

Currently, Linpus Linux Lite does not support this function.

My Monitor icons look too small/large, how can I reset it?

Currently, Linpus Linux Lite does not support this function.

How can I change the desktop background picture and/or background color?

Currently, Linpus Linux Lite does not support these functions.

How can I add/delete UI icons, adjust the UI position, or change the UI name?

Currently, Linpus Linux Lite does not support these functions.

Can I adjust the System Power Management settings?

At the lower right corner of the desktop Taskbar, there is a **KPowersave** icon.



Right click on the icon, and select **Setting CPU Frequency Method** from the menu.

Select the desired power management option from the following:

Performance→ CPU always runs at the higher speed.

Dynamic→ CPU speed depend on the user action.

Balance→ CPU always runs at the lower speed.

How can I browse the Aspire one Quick Guide?

Double click on **Help**, then use the tools provided in the window to browse the Aspire one Quick Guide.

Is there a shortcut back to the Home Page?

At the lower left corner of the Desktop Taskbar, there is a **Home** icon.



Click the icon to minimize all the open windows and display the Home page.

How can I read the date from USB drive and CD/DVD-ROM?

Plug in the USB drive or insert the CD in CD/DVD-Rom, Linpus Linux Lite will automatically detect and mount the device. A corresponding icon is placed in **My File** under the tab **File**. Clicks on the device to access the file or application.

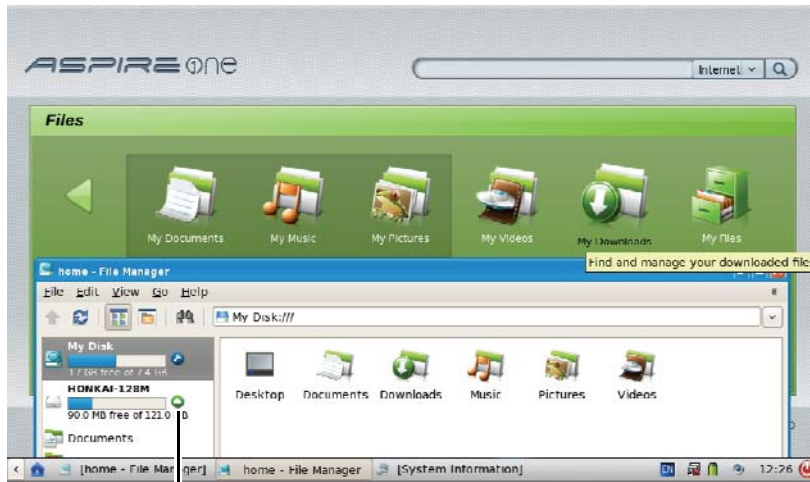

Green Icon

To unmount the device, right click on the green icon, and select **Unmount volume**.

What Wireless Network Security Protocols are supported by Linpus Linux Lite?

Linpus Linux Lite support the following security protocols:

- WEP 128 bit key
- WEP 40/104 Bit HEX
- WEP 40/128 Bit ASCII
- WPA & WPA2 Personal



Click on the network manager icon and select the desired wireless access point. The network manager automatically detects the security protocol and then requests the password.

How do I setup a Network Printer?

Using a Windows network as an example:

1. Select **Setting** → **Printer** and click **New Printer** on the Toolbar.
2. Set the **Selected Connection** as **Windows Printer via SAMBA**.
3. Click on the desired SMB print in **Shared**, select the printer and click Forward.
4. Select the printer's manufacturer and the model, go on the next page to setup the printer name.
5. Click **Apply** to complete the setup.

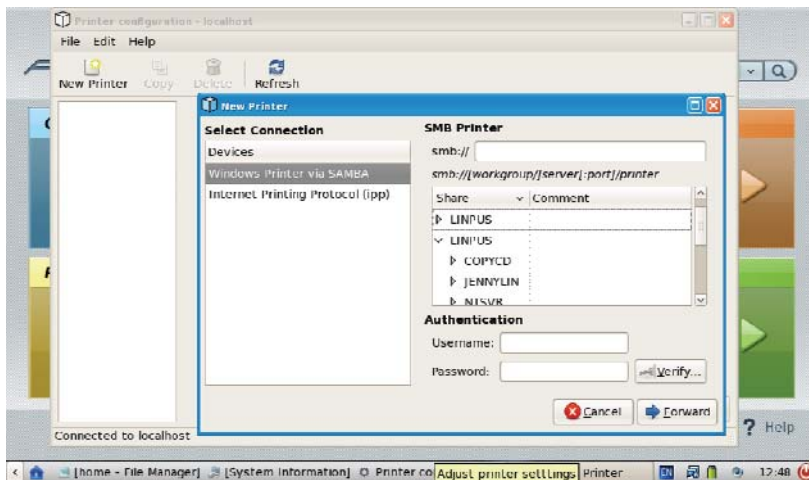

Why doesn't my Network Printer work?

When troubleshooting installation of the network printer, confirm whether the following conditions are true:

- Does the network device activate or not?
- Does your system connect successfully to local area network (LAN)?
- Does your system install Samba and activate the service?

When using the SMB common printer for Windows 95/98/NT, authentication is an important consideration. Using Windows 95/98, set the security setting as **Sharing Level** to avoid any such problems.

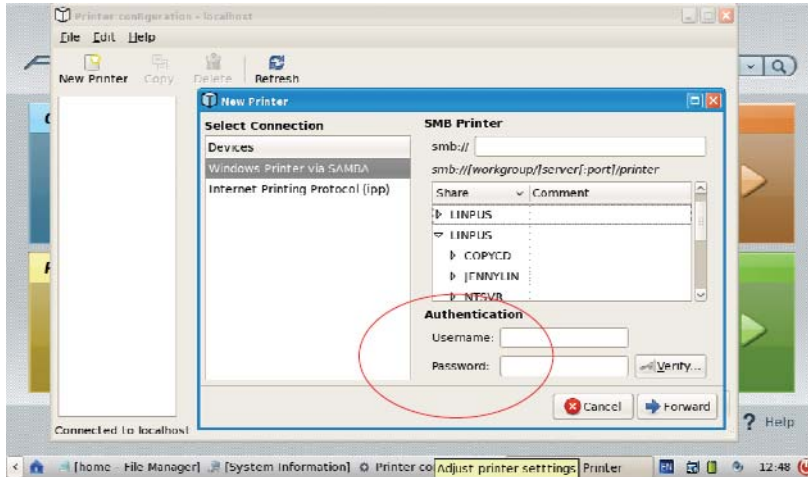

NOTE: Users can not use this method to avoid authentication on Windows NT platforms. In this case, the Linux user's account number and the password must be synchronized with Window NT otherwise the user will be unable to log in to the remote machine to access the network printer.

How do I share a local printer with the network?

Enter the printer settings, then select the shared printer. Enable the state **Shared**, to share the local printer on the network.

How do I update applications online?

Select **Settings**→ **Live Update** and enter the online update page, and press **Update**.

The system connects to the live update server automatically, and lists the available application updates. Click **Install** to download and install the applications.



How can I adjust the Date, Time, or Timezone?

Select **Settings** → **Date/Time** to display the setting menu. Make any desired adjustment to time, date, or time zone.

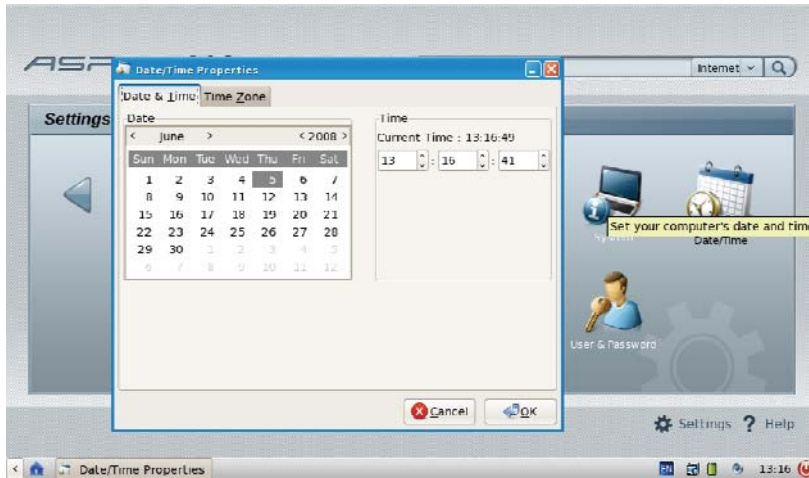

Where is the system performance monitor?

Press **Ctrl+Alt+Del** to display the **System Monitor**. Click **Resources** to view system status.

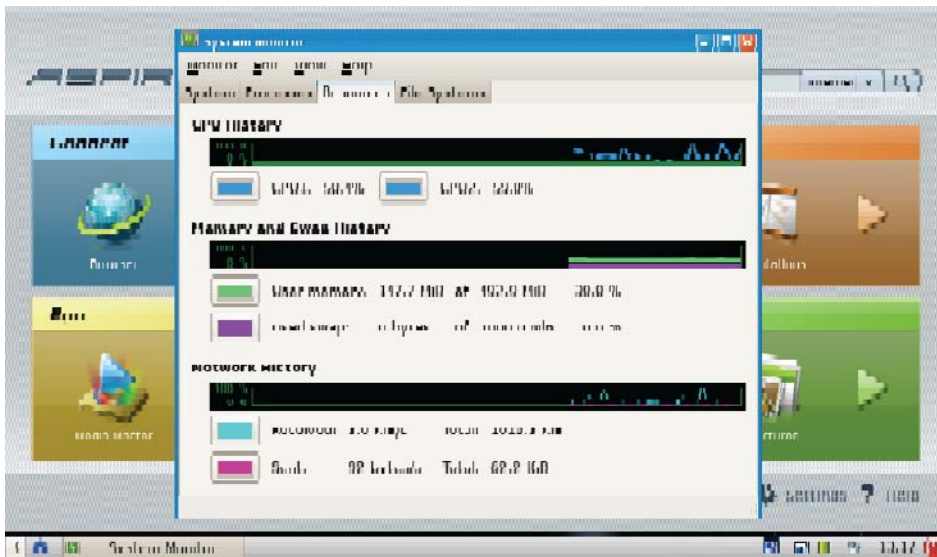

Where can I view peripheral devices available to my system?

Press **Ctrl+Alt+Del** to display the **System Monitor**. Click **File Systems** to view available peripheral devices.

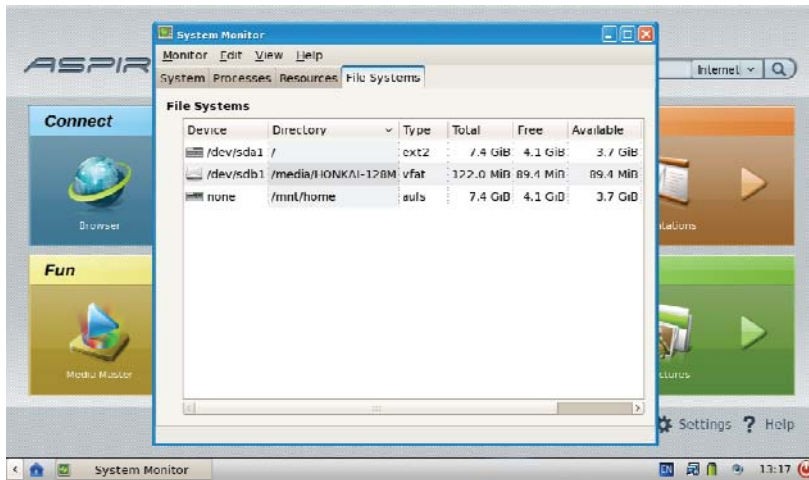

Where can I view processes running on my system?

Press **Ctrl+Alt+Del** to display the **System Monitor**. Click **Processes** to view programs and application status.

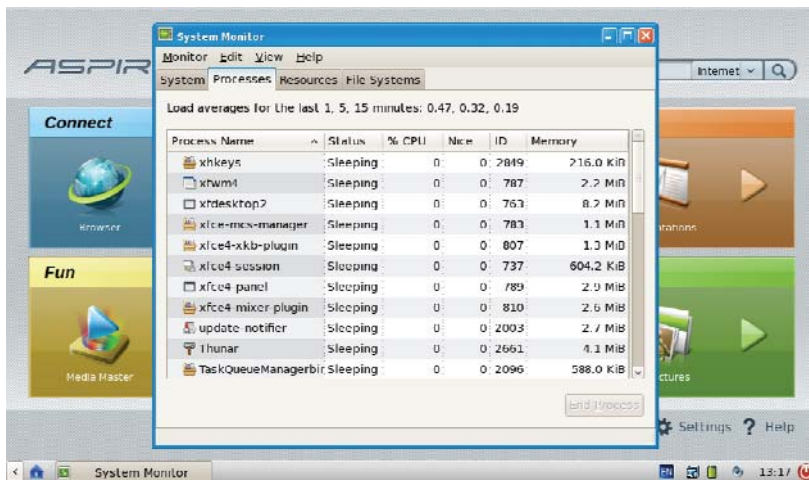

How can I set the screensaver?

Screensavers are not customizable with this version.

How can I reset the logon password?

Select **Settings**→ **User & Password**. Click **Change Password** and follow the onscreen prompts to change your password.



After using OpenOffice what happens to my old MS Office format files? Do I need to recreate the files? Is there a conversion utility?

OpenOffice can not only read MS Office format files, but also save files as MS Office 95/97/2000/XP format so there is no need to recreate the old files. In fact, for older file formats, OpenOffice performs excellently, even with MS Office 95 documents.

NOTE: If your documents contain complex page layouts or macros you may wish to consider recreating them using OpenOffice.

In addition, OpenOffice provides a file conversion wizard able to convert original MS Office file formats to OpenOffice format.

How to install and start the Webcam?

Select **Fun**→ **Webcam** to automatically detect the camera hardware. Follow the onscreen prompts and instruction on use.

How can I move or copy files?

To move a file, select **File Manager** and drag the file to the intended location.

To copy a file, select the file and click **Edit**→ **Copy** (or press the right key and choose **Copy**). Move to the intended location and click **Edit**→ **Paste** (or press the right key and choose **Paste**).

How do I shut-down the system?

Click the **Standby** icon in the task bar and select shut-down to close the system.



How do I transfer IE bookmarks to Firefox?

Select **File**→ **Import** on the Firefox function menu, then select the **Internet Explorer** bookmark you want to transfer. The IE bookmark can be accessed from the **my favorite** area.

How do I revisit webpages stored in Firefox?

You can open or tow **.html** or **.htm** files to Firefox directly, or you can set the Firefox window to open automatically to tow **.html** or **.htm** files directly. You can also use the **Open** document option in the menus.

Why are some Flash webpages unable to display normally in Firefox?

Ensure you have the latest Flash Player Installers from Linux in Adobe Lab (<http://labs.adobe.com/>).

How do I browse PDF files?

The system ships with Adobe Reader 8 for Linux, which can open pdfs directly and operates similarly to the Windows version.

Are there virus scanners available for Linux?

At present, about 99.xx% of viruses are aimed at attacking the Windows operating system, however, users of OpenOffice can open and view Microsoft Office documents that may contain viruses. These viruses don't infect the Linux computer but the user can easily attach and send infected documents unknowingly to other users who are at risk. For more information on viruses and available software go to www.openoffice.org.

Why is my webpage garbled?

The character encoding may not be automatically detected. Try selecting **View** → **Character encoding** and select the appropriate coding language.

How do I search for specific files?

There is a search bar on the desk-top upper right corner. Type the file name in the field provided, and click the magnifying glass icon to begin searching.

NOTE: Select **Local** from the drop down menu to search the local system only.



POST Code Reference Tables

These tables describe the POST codes and components of the POST process.

Sec:

NO_EVICTION_MODE_DEBUG EQU 1 (CommonPlatform\sec\ia32\SecCore.inc)

Code	Component
0xC2	MTRR setup
0xC3	Enable cache
0xC4	Establish cache tags
0xC5	Enter NEM, Place the BSP in No Fill mode, set CR0.CD = 1, CR0.NW = 0.
0xCF	Cache Init Finished

Memory:

DEBUG_BIOS EQU 1 (Chipset\Alviso\Memory\InitAsm\IA32\IMEMORY.INC)

Code	Component
0xA0	First memory check point
0x01	Enable MCHBAR
0x02	Check for DRAM initialization interrupt and reset fail
0x03	Verify all DIMMs are DDR or DDR2 and unbuffered
0x04	Detect an improper warm reset and handle
0x05	Detect if ECC SO-DIMMs are present in the system
0x06	Verify all DIMMs are single or double sided and not asymmetric
0x07	Verify all DIMMs are x8 or x16 width
0x08	Find a common CAS latency between the DIMMS and the MCH
0x09	Determine the memory frequency and CAS latency to program
0x10	Determine the smallest common TRAS for all DIMMs
0x11	Determine the smallest common TRP for all DIMMs
0x12	Determine the smallest common TRCD for all DIMMs
0x13	Determine the smallest refresh period for all DIMMs
0x14	Verify burst length of 8 is supported by all DIMMs
0x15	Determine the smallest tWR supported by all DIMMs
0x16	Determine DIMM size parameters
0x17	Program the correct system memory frequency
0x18	Determine and set the mode of operation for the memory channels
0x19	Program clock crossing registers
0x20	Disable Fast Dispatch
0x21	Program the DRAM Row Attributes and DRAM Row Boundary registers
0x22	Program the DRAM Bank Architecture register
0x23	Program the DRAM Timing & and DRAM Control registers
0x24	Program ODT
0x25	Perform steps required before memory init
0x26	Program the receive enable reference timing control register Program the DLL Timing Control Registers, RCOMP settings

Code	Component
0x27	Enable DRAM Channel I/O Buffers
0x28	Enable all clocks on populated rows
0x29	Perform JEDEC memory initialization for all memory rows
0x30	Perform steps required after memory init
0x31	Program DRAM throttling and throttling event registers
0x32	Setup DRAM control register for normal operation and enable
0x33	Enable RCOMP
0x34	Clear DRAM initialization bit in the SB
0x35	Initialization Sequence Completed, program graphic clocks
0xAF	Disable access to the XMM registers

BDS & Specific action:

Code	Component
0x00	Report the legacy boot is happening
0x12	Wake up the APs
0x13	Initialize SMM Private Data and relocate BSP SMBASE
0x21	PC init begin at the stage1
0x27	Report every memory range do the hard ware ECC init
0x28	Report status code of every memory range
0x50	Get the root bridge handle
0x51	Notify pci bus driver starts to program the resource
0x58	Reset the host controller
0x5A	IdeBus begin initialization
0x70	Simple Text Output Protocol Functions (VGA class reset)
0x71	Report that VGA Class driver is being disabled
0x72	Report that VGA Class driver is being enabled
0x78	Terminal Console In reset and Console Out reset
0x79	Report that the remote terminal is being disabled
0x7A	Report that the remote terminal is being enabled
0x90	Keyboard reset
0x91	USB Keyboard disable
0x92	Keyboard detection
0x93	Report that the usb keyboard is being enabled
0x94	Clear the keyboard buffer
0x95	Init Keyboard
0x98	Mouse reset
0x99	Mouse disable
0x9A	Detect PS2 mouse
0x9B	Report that the mouse is being enabled
0xB8	Peripheral removable media reset (ex: Is a Floppy, USB device)
0xB9	Peripheral removable media disable
0xBB	Peripheral removable media enable
0xE4	Report Status Code here for DXE_ENTRY_POINT once it is available

Code	Component
0xF8	Report that ExitBootServices() has been called
0xF9	Runtime driver set virtual address map

Each PEIM entry point used in 80_PORT

Code	Component
0x00	N/A
0x01	PEI_EVENT_LOG
0x02	PEI_OEM_SERVICE
0x03	PEI_SIO_INIT
0x04	PEI_MONO_STATUS_CODE
0x05	PEI_CPU_IO_PCI_CFG
0x06	PEI_CPU_IO
0x07	PEI_PCI_CFG
0x08	PEI_CPU_PEIM
0x09	PEI_PLATFORM_STAGE1
0x0A	PEI_VARIABLE
0x0B	PEI_SB_INIT
0x0C	PEI_CAPSULE
0x0D	PEI_PLATFORM_STAGE2
0x0E	PEI_SB_SMBUS_ARP_DISABLED
0x0F	PEI_HOST_TO_SYSTEM
0x10	PEI_MEMORY_INIT
0x11	PEI_S3_RESUME
0x12	PEI_CLOCK_GEN
0x13	PEI_OP_PRESENCE
0x14	PEI_TPM_TCG
0x15	PEI_FIND_FV
0x16	PEI_H2O_DEBUG_IO
0x17	PEI_H2O_DEBUG_COMM
0x18	PEI_SMM_CONTROL
0x19~0x1F	PEI_RESERVED
0x20~0x2E	PEI_OEM_DEFINED
0x2F	PEI_DXE_IPL

Each Driver entry point used in 80_PORT

Code	Component
0x30	RESERVED
0x31	DXE_CRC32_SECTION_EXTRACT
0x32	SCRIPT_SAVE
0x33	ACPI_S3_SAVE
0x34	SMART_TIMER
0x35	JPEG_DECODER
0x36	PCX_DECODER
0x37	HT_CPU / MP_CPU
0x38	LEGACY_METRONOME
0x39	FTWLITE
0x3A	RUN_RIME

Code	Component
0x3B	MONOTONIC_COUNTER
0x3C	WATCH_DOG_TIMER
0x3D	SECURITY_STUB
0x3E	DXE_CPU_IO
0x3F	CF9_RESET
0x40	PC_RTC
0x41	STATUS_CODE
0x42	VARIABLE
0x43	EMU_VARIABLE
0x44	DXE_CHIPSET_INIT
0x45	DXE_ALERT_FORMAT
0x46	PCI_HOST_BRIDGE
0x47	PCI_EXPRESS
0x48	DXE_SB_INIT
0x49	IDE_CONTROLLER
0x4A	SATA_CONTROLLER
0x4B	SB_SM_BUS
0x4C	ISA_ACPI_DRIVER
0x4D	ISA_BUS
0x4E	ISA_SERIAL
0x4F	IDE_BUS
0x50	PCI_BUS
0x51	BOOT_PRIORITY
0x52	FVB_SERVICE
0x53	ACPI_PLATFORM
0x54	PCI_HOT_PLUG
0x55	DXE_PLATFORM
0x56	PLATFORM_IDE
0x57	SMBIOS
0x58	MEMORY_SUB_CLASS
0x59	MISC_SUB_CLASS
0x5A	CON_PLATFORM
0x5B	SAVE_MEMORY_CONFIG
0x5C	ACPI_SUPPORT
0x5D	CON_SPLITTER_UGA_VGA / CON_SPLITTER
0x5E	VGA_CLASS
0x5F	DATA_HUB
0x60	DISK_IO
0x61	MEMORY_TEST
0x62	CRISIS_RECOVERY
0x63	LEGACY_8259
0x64	LEGACY_REGION
0x65	LEGACY_INTERRUPT

Code	Component
0x66	BIOS_KEYBOARD
0x67	BIOS_VEDIO
0x68	MONITER_KEY
0x69	LEGACY_BIOS
0x6A	LEGACY_BIOS_PLATFORM
0x6B	PCI_PLATFORM
0x6C	ISA_FLOOPY
0x6D	PS2_MOUSE
0x6E	USB_BOT
0x6F	USB_CBI0
0x70	USB_CBI1
0x71	USB_KB
0x72	USB_MASS_STORAGE
0x73	BUS_PCI_UHCI
0x74	USB_MOUSE
0x75	USB_BUS
0x76	SETUP_UTILITY
0x77	FW_BLOCK_SERVICE
0x78	USB_LEGACY_PLATFORM
0x79	GRAPHICS_CONSOLE
0x7A	TERMINAL
0x7B	DATA_HUB_STD_ERR
0x7C	FAT
0x7D	PARTITION
0x7E	ENGLISH
0x7F	FRENCH
0x80	HII_DATABASE
0x81	SETUP_BROWSER
0x82	OEM_SETUP_BROWSER
0x83	OEM_BADGING_SUPPORT
0x84	LEGACY_MOUSE
0x85	BIOS_SNP16
0x86	BUS_PCI_UNDI
0x87	SETUP_MOUSE
0x88	OEM_SETTING
0x89	MONITOR_KEY
0x8A	PLATFORM_BDS
0x8B	FAULT_TOLERANT_WRITE
0x8C	UPDATE_DISPATCHER
0x8D	CHINESE
0x8E	TPM_S3_Resume
0x8F	USB_EHCI
0x90	SNP_32_64

Code	Component
0x91	PXE_BC
0x92	PXE_DHCP4
0x93	EBC
0x94~0x9F	RESERVED
0xA0	DXE_H2O_DEBUG_IO
0xA1	DXE_H2O_DEBUG_IO
0xA2	DXE_TPM_TCG
0xA3	DXE_TPM_PHYSICAL_PRESENCE
0xA4	DXE_OEM_SERVICE
0xA5	DXE_EVENT_LOG
0xA6	DXE_SECURITY_HDD_PASSWORD_SERVICE
0xA7	DXE_LAN_ASF_INIT
0xA8	DXE_BUS_PCI_SERIAL
0xA9	DXE_LAN_IDER_CONTROLLER
0xAA	DXE_LAN_AMT
0xAB	DXE_SECURITY_SYSTEM_PASSWORD_SERVICE
0xAC	DXE_SECURITY_PASSWORD_CONSOLE
0xAD	DXE_DATA_HUB_RECORD_POLICY
0xAE	DXE_TPM_DRIVER
0xAF	RESERVED
0xB0	JAPANESE
0xB1	DXE_UNICODE_COLLATION

Each SmmDriver entry point used in 80_PORT

Code	Component
0xC0	SMM_ACCESS
0xC1	SMM_CONTROL
0xC2	SMM_BASE
0xC3	SMMAP
0xC4	SMMCORE
0xC5	SMM_DISPATCH
0xC6	SMM_START
0xC7	SMM_RUNTIME
0xC8	SB_SMM_DISPATCH
0xC9	SMM_THUNK
0xCA	SMM_ACPI_SW_CHILD
0xCB	SMM_SB_S3_SAVE
0xCC	SMM_PLATFORM
0xCD	SMM_GMCH_MBI
0xCE	SMM_FW_BLOCK_SERVICE
0xCF	SMM_VARIABLE
0xD0	SMM_IHISI
0xD1	SMM_INT15_MICROCODE

Code	Component
0xD2	SMM_PNP
0xD3	SMM_USB_LEGACY
0xD4	SMM_INT13_HDD
0xD5	SMM_INIT_PPM
0xD6	SMM_OHCI1394
0xD7	SMM_SECURITY_HDD_PASSWORD_SERVICE
0xD8	SMM_OEM_SERVICE
0xD9	SMM_PPM
0xDA	SMM_DIGITAL_THERMAL_SENSOR

Jumper and Connector Locations

Top View

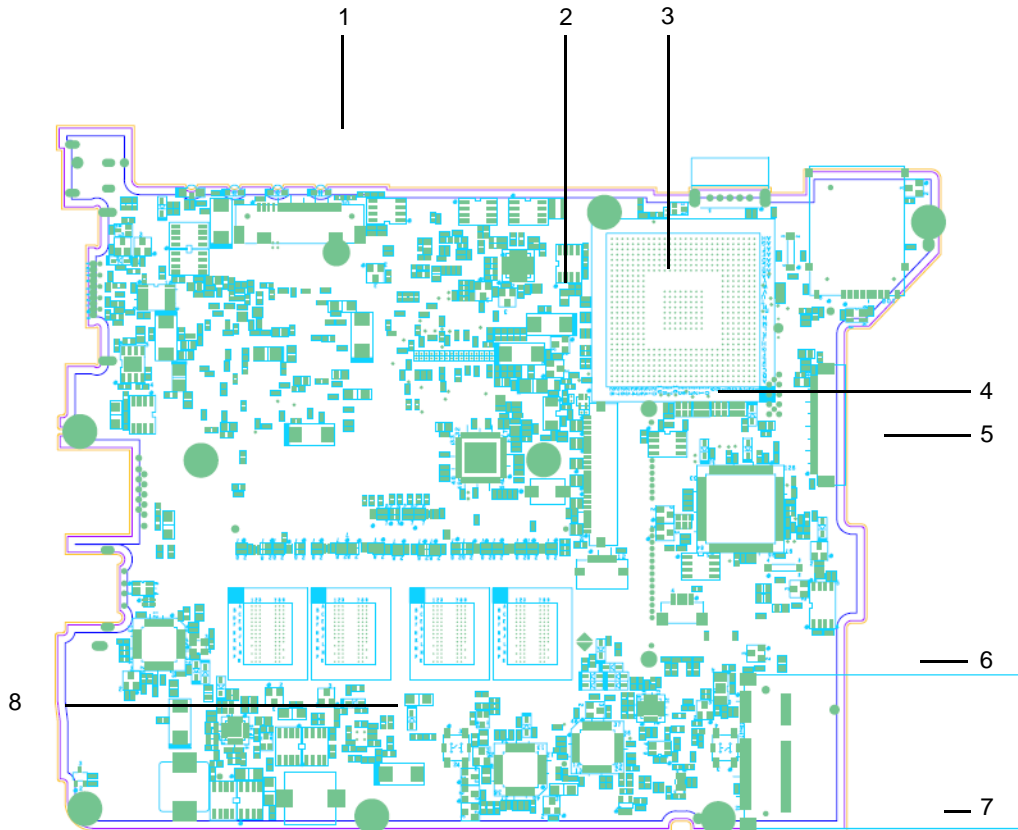

No.	Description	No.	Description
1	LCD Connector	5	MDC Connector
2	Powerboard Connector	6	ExpressCard Board Connector
3	Keyboard Connector	7	Bluetooth Connector
4	DDR3 Connector	8	PCMCIA Connector

Bottom View

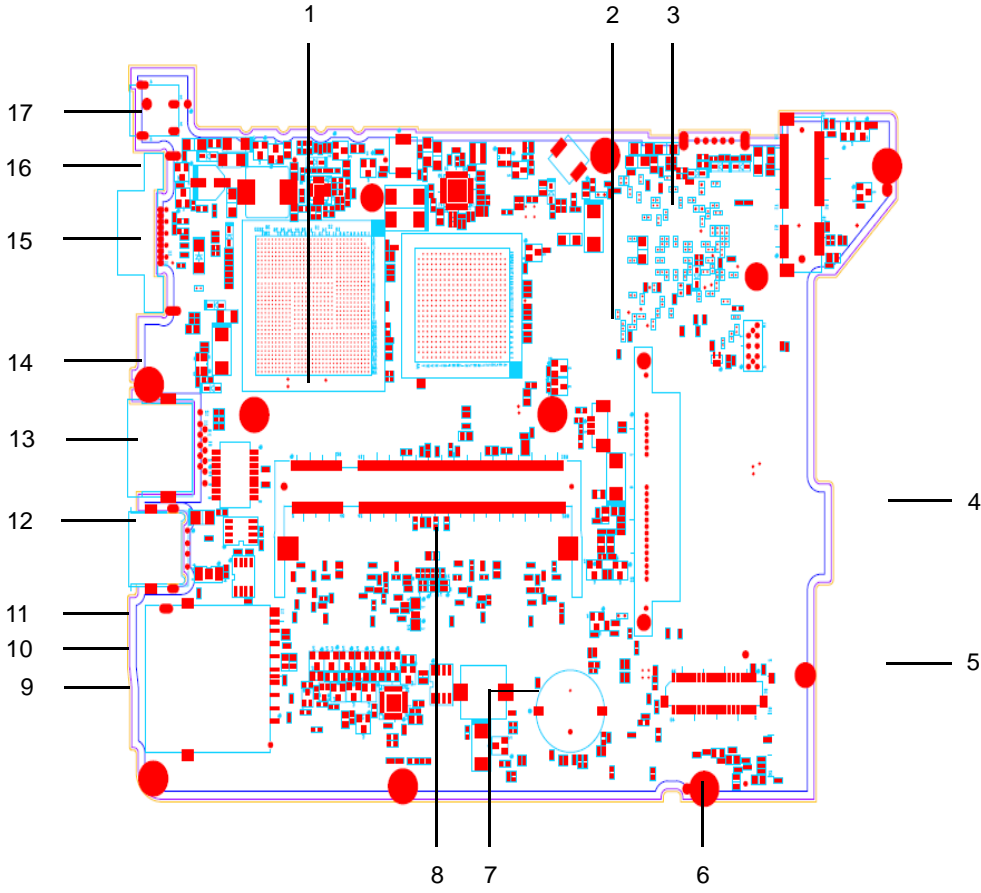

No.	Description	No.	Description
1	CPU Socket	10	Audio Connector
2	DDR2 Connector	11	SPDIF Connector
3	Battery Connector	12	USB Connector
4	ODD Connector	13	HDMI Connector
5	HDD Connector	14	CRT Connector
6	Card Reader Connector	15	Docking Connector
7	HDD Connector	16	RJ 45
8	MXM Connector	17	DC Jack
9	Audio Connector		

Clearing Password Check and BIOS Recovery

This section provide you the standard operating procedures of clearing password and BIOS recovery for Aspire one. Aspire one provide one Hardware Open Gap on main board for clearing password check, and one Hotkey for enabling BIOS Recovery.

Clearing Password Check

Hardware Open Gap Description

Item	Description
G1	Clear CMOS Jumper

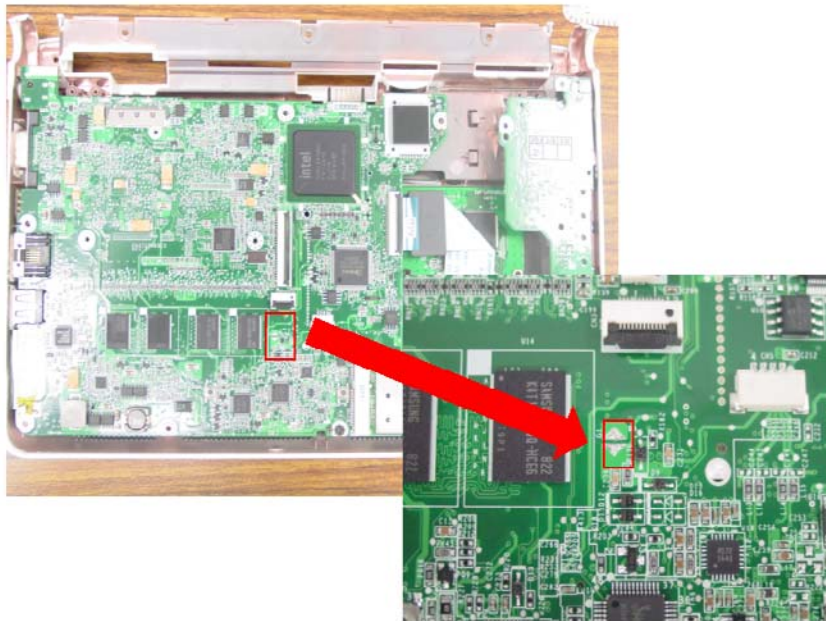

Steps for Clearing BIOS Password Check

If users set BIOS Password (Supervisor Password and/or User Password) for a security reason, BIOS will ask the password during systems POST or when systems enter to BIOS Setup menu. However, once it is necessary to bypass the password check, users need to short the HW Gap to clear the password by the following steps:

- Power Off a system, and remove HDD, AC and Battery from the machine.
- Open the back cover of the machine, and find out the HW Gap on M/B as picture.
- Use an electric conductivity tool to short the two points of the HW Gap.
- Plug in AC, keep the short condition on the HW Gap, and press Power Button to power on the system till BIOS POST finish. Then remove the tool from the HW Gap.
- Restart system. Press F2 key to enter BIOS Setup menu.
- If there is no Password request, BIOS Password is cleared. Otherwise, please follow the steps and try again.

NOTE: The steps are only for clearing BIOS Password (Supervisor Password and User Password).

BIOS Recovery by Crisis Disk

BIOS Recovery Boot Block:

BIOS Recovery Boot Block is a special block of BIOS. It is used to boot up the system with minimum BIOS initialization. Users can enable this feature to restore the BIOS firmware to a successful one once the previous BIOS flashing process failed.

BIOS Recovery Hotkey:

The system provides a function hotkey: **Fn+Esc**, for enable BIOS Recovery process when system is powered on during BIOS POST. To use this function, it is strongly recommended to have the AC adapter and Battery present. If this function is enabled, the system will force the BIOS to enter a special BIOS block, called Boot Block.

Steps for BIOS Recovery from USB Storage:

Before doing this, prepare the Crisis USB key. The Crisis USB key could be made by executing the Crisis Disk program in another system with Windows XP OS.

Follow the steps below:

1. Save ROM file (file name: **JAL90x64.fd**) to the root directory of USB storage.
2. Plug USB storage into USB port.
3. Press **Fn + ESC** button then plug in AC.
The Power button flashes once.
4. Press **Power** button to initiate system CRISIS mode.
When CRISIS is complete, the system auto restarts with a workable BIOS.
5. Update the latest version BIOS for this machine by regular BIOS flashing process.

FRU (Field Replaceable Unit) List

This chapter gives you the FRU (Field Replaceable Unit) listing in global configurations of Aspire one. Refer to this chapter whenever ordering for parts to repair or for RMA (Return Merchandise Authorization).

Please note that WHEN ORDERING FRU PARTS, you should check the most up-to-date information available on your regional web or channel. For whatever reasons a part number change is made, it will not be noted on the printed Service Guide. For ACER AUTHORIZED SERVICE PROVIDERS, your Acer office may have a DIFFERENT part number code from those given in the FRU list of this printed Service Guide. You MUST use the local FRU list provided by your regional Acer office to order FRU parts for repair and service of customer machines.

NOTE: To scrap or to return the defective parts, you should follow the local government ordinance or regulations on how to dispose it properly, or follow the rules set by your regional Acer office on how to return it.

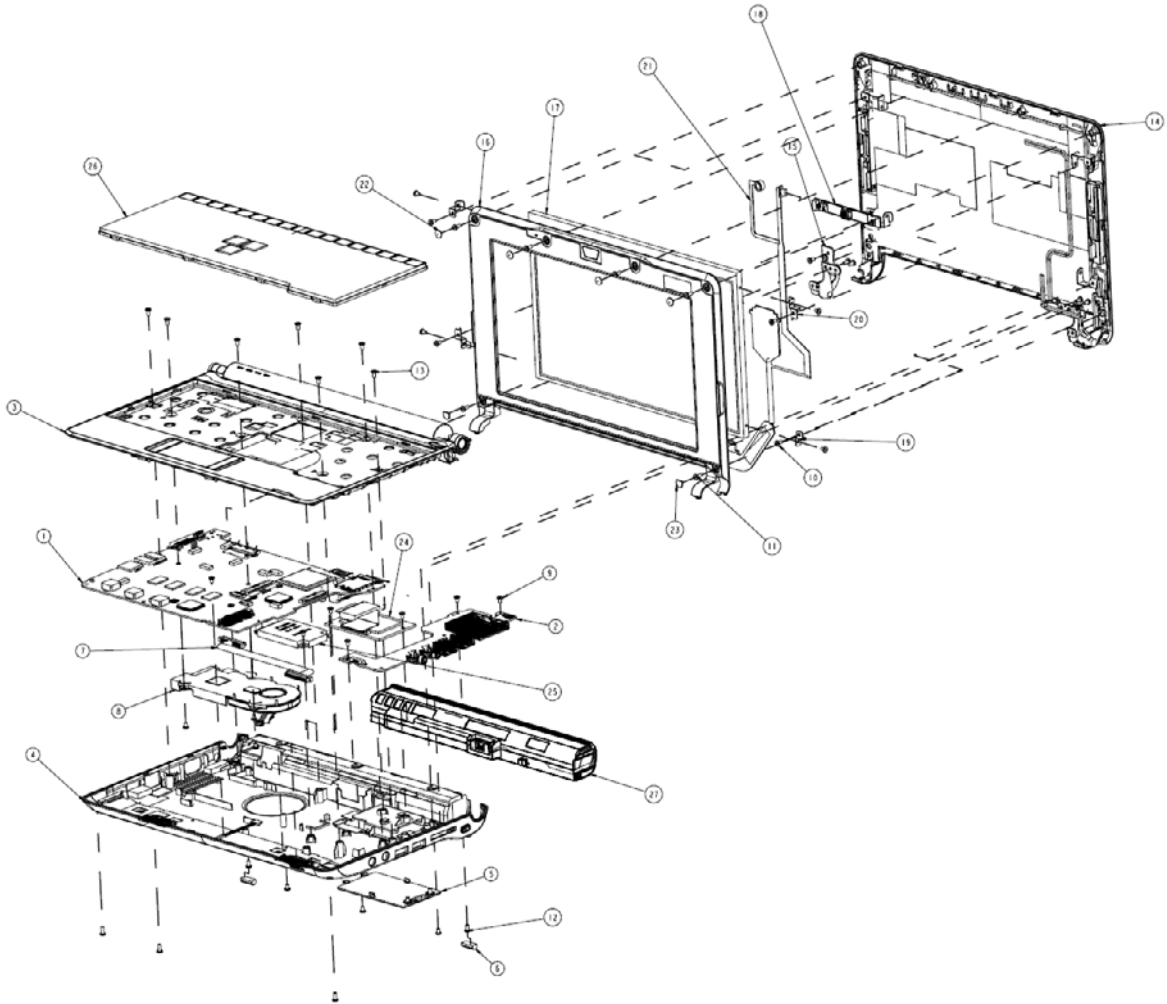

Aspire one Exploded Diagram





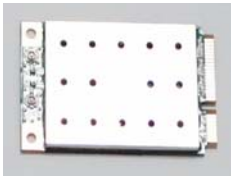

Item	Description	Part Number	Item	Description	Part Number
1	Mainboard	MB.S0306.001 (SDD SKU) MB.S0506.001 (HDD SKU)	15	Left Hinge	33.S0207.001
2	Power Board	55.S0207.001	16	LCD Bezel	60.S0207.004
3	Upper Case	60.S0207.001 60.S0607.001 60.S0307.001 60.S0707.001	17	LCD Panel	LK.08905.002 LK.0890D.001
4	Lower Case	60.S0207.002 60.S0407.001 60.S0607.002 60.S0807.001 60.S0307.002 60.S0507.001 60.S0707.002 60.S0907.001	18	Camera Module	57.S0207.001 57.S0207.002



Item	Description	Part Number	Item	Description	Part Number
5	3G Cover	42.S0207.001 42.S0307.001 42.S0407.001 42.S0507.001	19	LCD Bracket	33.S0207.002
6	Rubber Foot	47.S0207.003	20	Mirror LCD Bracket	33.S0207.003
7	Card Reader Cable	50.S0207.001	21	LCD Cable	50.S0207.003
8	Thermal Module	60.S0207.005	22	Rubber Screw Cap	47.S0207.001
9	Screw	See "Screw List" on page 126.	23	Mylar Screw Cap	47.S0207.002
10	Screw		24	SSD	KF.4GB0D.002 KF.4GB0N.003 KF.8GB0N.001
11	Screw		25	3G Module	54.S0207.001
12	Screw		26	Keyboard	See "Keyboard" on page 121.
13	Screw		27	Battery	AP.03003.001
14	LCD Case	60.S0207.003 60.S0607.003 60.S0307.003 60.S0707.003			

Aspire one FRU List

Category	Description	Part No.
Adapter		
	ADAPTER LITE-ON 30W 1.7X5.5X11 BLACK PA-1300-04AC LF	AP.03003.001
Battery		
	BATTERY SIMPLO UM-2008AW LI-ION 3S1P PANASONIC 3 CELL 2200MAH MAIN COMMON MACLES / WHITE	BT.00307.004
	BATTERY SIMPLO UM-2008A LI-ION 3S1P SAMSUNG 3 CELL 4400MAH MAIN COMMON MACLES	BT.00307.002
	BATTERY SIMPLO UM-2008A LI-ION 3S1P SAMSUNG 3 CELL 4800MAH MAIN COMMON MACLES	BT.00307.003
	Battery SIMPLO UM-2008AW Li-Ion 3S1P SAMSUNG 3 cell 2200mAh Main COMMON Macles / White	BT.00307.005
	Battery SIMPLO UM-2008A Li-Ion 3S1P PANASONIC 3 cell 4400mAh Main COMMON Macles	BT.00307.001
	Battery SIMPLO UM-2008B Li-Ion 3S2P PANASONIC 6 cell 5200mAh Main COMMON Macles Black	BT.00607.041
	SIMPLO UM-2008BW Li-Ion 3S2P SAMSUNG 6 cell 5200mAh Main COMMON Macles WHITE	BT.00607.044
Board		
	WLAN 802.11 B/G T60H976.11	54.S0207.001
	CAMERA 0.3M 08P017	57.S0207.001
	CAMERA 0.3M CN0316-M608-OV01	57.S0207.002
	LED POWER BOARD W/ 5 IN 1 CARD READER	55.S0207.001

Category	Description	Part No.
Cables		
	POWER CORD US 3PIN ROHS	27.TAXV7.001
	POWER CORD PRC 3P Y536B30001218008	27.TATV7.004
	POWER CORD(S.A) 1.8M 3BLACK FZ010008-006	27.T48V7.001
	ARGENTINE POWER CORD 3 PIN BLACK	27.S0207.001
	POWER CORD AU W/LABEL (3 PIN)	27.A50V7.003
	POWER CORD(EU) 1.8M 3PBLACK FM010008-010	27.TATV7.001
	PWR CORD V943B30001218008 DANISH 3P	27.A03V7.006
	PWR CORD(ISR)1.8M 3PBLK FZ0I0008-038	27.A50V7.002
	POWER CORD ITALIAN 3PIN	27.A99V7.005
	POWER CORD JAPAN	27.TAXV7.003
	POWER CORD AF-S (INDIA)	27.A50V7.001
	POWER CORD SWISS 3 PIN	27.A99V7.004
	POWER CORD (UK)	27.A03V7.004
	POWER CORD US-110V (BSMI)	27.A99V7.002
	CABLE - LED POWER/B TO MB	50.S0207.001
	FFC CABLE - SSD TO MB	50.S0207.002
	LCD CABLE	50.S0207.003
Case/Cover/Bracket/Assembly		
	UPPER CASE ASSY WHITE COLOR W/TP FFC	60.S0207.001
	LOWER CASE ASSY WHITE COLOR W/SPEAKER FOR WLAN	60.S0207.002
	LOWER CASE ASSY WHITE COLOR HDD W/SPEAKER FOR WLAN	60.S0407.001
	UPPER CASE ASSY WHITE COLOR W/TP FFC FOR 3G	60.S0607.001
	LOWER CASE ASSY WHITE COLOR W/SPEAKER FOR WLAN 3G	60.S0607.002
	LOWER CASE ASSY WHITE COLOR HDD W/SPEAKER FOR WLAN 3G	60.S0807.001
	UPPER CASE ASSY BLUE COLOR W/TP FFC	60.S0307.001
	LOWER CASE ASSY BLUE COLOR W/SPEAKER FOR WLAN	60.S0307.002





Category	Description	Part No.
	LOWER CASE ASSY BLUE COLOR HDD W/SPEAKER FOR WLAN	60.S0507.001
	UPPER CASE ASSY BLUE COLOR W/TP FFC FOR 3G	60.S0707.001
	LOWER CASE ASSY BLUE COLOR W/SPEAKER FOR WLAN 3G	60.S0707.002
	LOWER CASE ASSY BLUE COLOR HDD W/SPEAKER FOR WLAN 3G	60.S0907.001
	3G COVER WHITE COLOR	42.S0207.001
	3G COVER BLUE COLOR	42.S0307.001
	3G COVER WHITE COLOR FOR HDD SKU	42.S0407.001
	3G COVER BLUE COLOR FOR HDD SKU	42.S0507.001
	LCD COVER ASSY WHITE COLOR W/HINGE FOR WLAN	60.S0207.003
	LCD COVER ASSY WHITE COLOR W/HINGE FOR WLAN 3G	60.S0607.003
	LCD COVER ASSY BLUE COLOR W/HINGE FOR WLAN	60.S0307.003
	LCD COVER ASSY BLUE COLOR W/HINGE FOR WLAN 3G	60.S0707.003
	LCD BEZEL ASSY	60.S0207.004
	LCD HINGE - LEFT	33.S0207.001
	LCD BRACKET	33.S0207.002
	LCD BRACKET - MIRROR	33.S0207.003
HDD		
	HDD HGST 2.5" 5400RPM 80GB HTS543280L9A300 FALCON B SATA LF F/W:C40C	KH.08007.028
	HDD WD 2.5" 5400RPM 80GB WD800BEVT-22ZCT0 ML160 SATA LF F/W:11.01A11	KH.08008.035

Category	Description	Part No.
	HDD BRACKET	33.S0207.004
SDD		
	FLASH DISK SANDISK FLASH MODULE NAND 4GB SDUS5FJ-004G LF	KF.4GB0D.002
	FLASH DISK INTEL FLASH MODULE NAND 4GB SSDPAMM0004G1 LF MM#898543	KF.4GB0N.003
	Flash Disk INTEL Flash Module NAND 8GB SSDPAMM0008G1 LF MM#898544	KF.8GB0N.001
Keyboard		
	KEYBOARD 8KB-FV1 BLACK MACLES 84KS BLACK TRADITIONAL CHINESE	KB.INT00.540
	KEYBOARD 8KB-FV1 BLACK MACLES 84KS BLACK GREEK	KB.INT00.533
	KEYBOARD 8KB-FV1 BLACK MACLES 84KS BLACK THAILAND	KB.INT00.517
	KEYBOARD 8KB-FV1 BLACK MACLES 85KS BLACK SLO/CRO	KB.INT00.522
	KEYBOARD 8KB-FV1 BLACK MACLES 85KS BLACK CZECH	KB.INT00.539
	KEYBOARD 8KB-FV1 BLACK MACLES 85KS BLACK HUNGARIAN	KB.INT00.532
	KEYBOARD 8KB-FV1 BLACK MACLES 85KS BLACK POLISH	KB.INT00.525
	KEYBOARD 8KB-FV1 BLACK MACLES 85KS BLACK BRAZILIAN PORTUGUESE	KB.INT00.542
	KEYBOARD 8KB-FV1 BLACK MACLES 84KS BLACK RUSSIAN	KB.INT00.523
	KEYBOARD 8KB-FV1 BLACK MACLES 85KS BLACK SLOVAK	KB.INT00.521
	KEYBOARD 8KB-FV1 BLACK MACLES 85KS BLACK TURKISH	KB.INT00.516
	KEYBOARD 8KB-FV1 BLACK MACLES 85KS BLACK BELGIUM	KB.INT00.543
	KEYBOARD 8KB-FV1 BLACK MACLES 85KS BLACK SWEDISH	KB.INT00.519
	KEYBOARD 8KB-FV1 BLACK MACLES 85KS BLACK UK	KB.INT00.515
	KEYBOARD 8KB-FV1 BLACK MACLES 85KS BLACK FRENCH	KB.INT00.535
	KEYBOARD 8KB-FV1 BLACK MACLES 85KS BLACK GERMAN	KB.INT00.534
	KEYBOARD 8KB-FV1 BLACK MACLES 85KS BLACK DUTCH	KB.INT00.537
	KEYBOARD 8KB-FV1 BLACK MACLES 85KS BLACK ITALIAN	KB.INT00.529
	KEYBOARD 8KB-FV1 BLACK MACLES 88KS BLACK JAPANESE	KB.INT00.548
	KEYBOARD 8KB-FV1 BLACK MACLES 85KS BLACK CANADIAN FRENCH	KB.INT00.541
	KEYBOARD 8KB-FV1 BLACK MACLES 85KS BLACK DANISH	KB.INT00.538
KEYBOARD 8KB-FV1 BLACK MACLES 85KS BLACK SPANISH	KB.INT00.520	
KEYBOARD 8KB-FV1 BLACK MACLES 84KS BLACK ARABIC/ ENGLISH	KB.INT00.544	
KEYBOARD 8KB-FV1 BLACK MACLES 84KS BLACK US INTERNATIONAL	KB.INT00.513	
KEYBOARD 8KB-FV1 BLACK MACLES 85KS BLACK SWISS/G	KB.INT00.518	

Category	Description	Part No.
	KEYBOARD 8KB-FV1 BLACK MACLES 85KS BLACK PORTUGUESE	KB.INT00.524
	KEYBOARD 8KB-FV1 BLACK MACLES 84KS BLACK US INTERNATIONAL HEBREW	KB.INT00.514
	KEYBOARD 8KB-FV1 BLACK MACLES 85KS BLACK NORWEGIAN	KB.INT00.526
	KEYBOARD 8KB-FV1 BLACK MACLES 84KS BLACK KOREAN	KB.INT00.528
	KEYBOARD 8KB-FV2 WHITE MACLES 84KS WHITE TRADITIONAL CHINESE	KB.INT00.696
	KEYBOARD 8KB-FV2 WHITE MACLES 84KS WHITE GREEK	KB.INT00.689
	KEYBOARD 8KB-FV2 WHITE MACLES 84KS WHITE THAILAND	KB.INT00.672
	KEYBOARD 8KB-FV2 WHITE MACLES 85KS WHITE SLO/CRO	KB.INT00.677
	KEYBOARD 8KB-FV2 WHITE MACLES 85KS WHITE CZECH	KB.INT00.695
	KEYBOARD 8KB-FV2 WHITE MACLES 85KS WHITE HUNGARIAN	KB.INT00.688
	KEYBOARD 8KB-FV2 WHITE MACLES 85KS WHITE POLISH	KB.INT00.680
	KEYBOARD 8KB-FV2 WHITE MACLES 85KS WHITE BRAZILIAN PORTUGUESE	KB.INT00.698
	KEYBOARD 8KB-FV2 WHITE MACLES 84KS WHITE RUSSIAN	KB.INT00.678
	KEYBOARD 8KB-FV2 WHITE MACLES 85KS WHITE SLOVAK	KB.INT00.676
	KEYBOARD 8KB-FV2 WHITE MACLES 85KS WHITE TURKISH	KB.INT00.671
	KEYBOARD 8KB-FV2 WHITE MACLES 85KS WHITE BELGIUM	KB.INT00.699
	KEYBOARD 8KB-FV2 WHITE MACLES 85KS WHITE SWEDISH	KB.INT00.674
	KEYBOARD 8KB-FV2 WHITE MACLES 85KS WHITE UK	KB.INT00.670
	KEYBOARD 8KB-FV2 WHITE MACLES 85KS WHITE FRENCH	KB.INT00.691
	KEYBOARD 8KB-FV2 WHITE MACLES 85KS WHITE GERMAN	KB.INT00.690
	KEYBOARD 8KB-FV2 WHITE MACLES 85KS WHITE DUTCH	KB.INT00.693
	KEYBOARD 8KB-FV2 WHITE MACLES 85KS WHITE ITALIAN	KB.INT00.685
	KEYBOARD 8KB-FV2 WHITE MACLES 88KS WHITE JAPANESE	KB.INT00.704
	KEYBOARD 8KB-FV2 WHITE MACLES 85KS WHITE CANADIAN FRENCH	KB.INT00.697
	KEYBOARD 8KB-FV2 WHITE MACLES 85KS WHITE DANISH	KB.INT00.694
	KEYBOARD 8KB-FV2 WHITE MACLES 85KS WHITE SPANISH	KB.INT00.675
	KEYBOARD 8KB-FV2 WHITE MACLES 84KS WHITE ARABIC/ ENGLISH	KB.INT00.700
	KEYBOARD 8KB-FV2 WHITE MACLES 84KS WHITE US INTERNATIONAL	KB.INT00.668
	KEYBOARD 8KB-FV2 WHITE MACLES 85KS WHITE SWISS/G	KB.INT00.673
	KEYBOARD 8KB-FV2 WHITE MACLES 85KS WHITE PORTUGUESE	KB.INT00.679
	KEYBOARD 8KB-FV2 WHITE MACLES 84KS WHITE US INTERNATIONAL HEBREW	KB.INT00.669
	KEYBOARD 8KB-FV2 WHITE MACLES 85KS WHITE NORWEGIAN	KB.INT00.681
KEYBOARD 8KB-FV2 WHITE MACLES 84KS WHITE KOREAN	KB.INT00.683	

Category	Description	Part No.
	KEYBOARD 8KB-FV1L BLACK MACLES 84KS BLACK TRADITIONAL CHINESE (LINUX)	KB.INT00.618
	KEYBOARD 8KB-FV1L BLACK MACLES 84KS BLACK GREEK (LINUX)	KB.INT00.611
	KEYBOARD 8KB-FV1L BLACK MACLES 84KS BLACK THAILAND (LINUX)	KB.INT00.594
	KEYBOARD 8KB-FV1L BLACK MACLES 85KS BLACK SLO/ CRO (LINUX)	KB.INT00.599
	KEYBOARD 8KB-FV1L BLACK MACLES 85KS BLACK CZECH (LINUX)	KB.INT00.617
	KEYBOARD 8KB-FV1L BLACK MACLES 85KS BLACK HUNGARIAN (LINUX)	KB.INT00.610
	KEYBOARD 8KB-FV1L BLACK MACLES 85KS BLACK POLISH (LINUX)	KB.INT00.602
	KEYBOARD 8KB-FV1L BLACK MACLES 85KS BLACK BRAZILIAN PORTUGUESE (LINUX)	KB.INT00.620
	KEYBOARD 8KB-FV1L BLACK MACLES 84KS BLACK RUSSIAN (LINUX)	KB.INT00.600
	KEYBOARD 8KB-FV1L BLACK MACLES 85KS BLACK SLOVAK (LINUX)	KB.INT00.598
	KEYBOARD 8KB-FV1L BLACK MACLES 85KS BLACK TURKISH (LINUX)	KB.INT00.593
	KEYBOARD 8KB-FV1L BLACK MACLES 85KS BLACK BELGIUM (LINUX)	KB.INT00.621
	KEYBOARD 8KB-FV1L BLACK MACLES 85KS BLACK SWEDISH (LINUX)	KB.INT00.596
	KEYBOARD 8KB-FV1L BLACK MACLES 85KS BLACK UK (LINUX)	KB.INT00.592
	KEYBOARD 8KB-FV1L BLACK MACLES 85KS BLACK FRENCH (LINUX)	KB.INT00.613
	KEYBOARD 8KB-FV1L BLACK MACLES 85KS BLACK GERMAN (LINUX)	KB.INT00.612
	KEYBOARD 8KB-FV1L BLACK MACLES 85KS BLACK DUTCH (LINUX)	KB.INT00.615
	KEYBOARD 8KB-FV1L BLACK MACLES 85KS BLACK ITALIAN (LINUX)	KB.INT00.607
	KEYBOARD 8KB-FV1L BLACK MACLES 88KS BLACK JAPANESE (LINUX)	KB.INT00.626
	KEYBOARD 8KB-FV1L BLACK MACLES 85KS BLACK CANADIAN FRENCH (LINUX)	KB.INT00.619
	KEYBOARD 8KB-FV1L BLACK MACLES 85KS BLACK DANISH (LINUX)	KB.INT00.616
	KEYBOARD 8KB-FV1L BLACK MACLES 85KS BLACK SPANISH (LINUX)	KB.INT00.597
	KEYBOARD 8KB-FV1L BLACK MACLES 84KS BLACK ARABIC/ ENGLISH (LINUX)	KB.INT00.622
	KEYBOARD 8KB-FV1L BLACK MACLES 84KS BLACK US INTERNATIONAL (LINUX)	KB.INT00.590
KEYBOARD 8KB-FV1L BLACK MACLES 85KS BLACK SWISS/ G (LINUX)	KB.INT00.595	

Category	Description	Part No.
	KEYBOARD 8KB-FV1L BLACK MACLES 85KS BLACK PORTUGUESE (LINUX)	KB.INT00.601
	KEYBOARD 8KB-FV1L BLACK MACLES 84KS BLACK US INTERNATIONAL HEBREW (LINUX)	KB.INT00.591
	KEYBOARD 8KB-FV1L BLACK MACLES 85KS BLACK NORWEGIAN (LINUX)	KB.INT00.603
	KEYBOARD 8KB-FV1L BLACK MACLES 84KS BLACK KOREAN (LINUX)	KB.INT00.605
	KEYBOARD 8KB-FV2L WHITE MACLES 84KS WHITE TRADITIONAL CHINESE (LINUX)	KB.INT00.734
	KEYBOARD 8KB-FV2L WHITE MACLES 84KS WHITE GREEK (LINUX)	KB.INT00.727
	KEYBOARD 8KB-FV2L WHITE MACLES 84KS WHITE THAILAND (LINUX)	KB.INT00.710
	KEYBOARD 8KB-FV2L WHITE MACLES 85KS WHITE SLO/ CRO (LINUX)	KB.INT00.715
	KEYBOARD 8KB-FV2L WHITE MACLES 85KS WHITE CZECH (LINUX)	KB.INT00.733
	KEYBOARD 8KB-FV2L WHITE MACLES 85KS WHITE HUNGARIAN (LINUX)	KB.INT00.726
	KEYBOARD 8KB-FV2L WHITE MACLES 85KS WHITE POLISH (LINUX)	KB.INT00.718
	KEYBOARD 8KB-FV2L WHITE MACLES 85KS WHITE BRAZILIAN PORTUGUESE (LINUX)	KB.INT00.736
	KEYBOARD 8KB-FV2L WHITE MACLES 84KS WHITE RUSSIAN (LINUX)	KB.INT00.716
	KEYBOARD 8KB-FV2L WHITE MACLES 85KS WHITE SLOVAK (LINUX)	KB.INT00.714
	KEYBOARD 8KB-FV2L WHITE MACLES 85KS WHITE TURKISH (LINUX)	KB.INT00.709
	KEYBOARD 8KB-FV2L WHITE MACLES 85KS WHITE BELGIUM (LINUX)	KB.INT00.737
	KEYBOARD 8KB-FV2L WHITE MACLES 85KS WHITE SWEDISH (LINUX)	KB.INT00.712
	KEYBOARD 8KB-FV2L WHITE MACLES 85KS WHITE UK (LINUX)	KB.INT00.708
	KEYBOARD 8KB-FV2L WHITE MACLES 85KS WHITE FRENCH (LINUX)	KB.INT00.729
	KEYBOARD 8KB-FV2L WHITE MACLES 85KS WHITE GERMAN (LINUX)	KB.INT00.728
	KEYBOARD 8KB-FV2L WHITE MACLES 85KS WHITE DUTCH (LINUX)	KB.INT00.731
	KEYBOARD 8KB-FV2L WHITE MACLES 85KS WHITE ITALIAN (LINUX)	KB.INT00.723
	KEYBOARD 8KB-FV2L WHITE MACLES 88KS WHITE JAPANESE (LINUX)	KB.INT00.742
	KEYBOARD 8KB-FV2L WHITE MACLES 85KS WHITE CANADIAN FRENCH (LINUX)	KB.INT00.735
KEYBOARD 8KB-FV2L WHITE MACLES 85KS WHITE DANISH (LINUX)	KB.INT00.732	

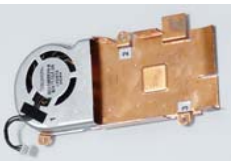
Category	Description	Part No.
	KEYBOARD 8KB-FV2L WHITE MACLES 85KS WHITE SPANISH (LINUX)	KB.INT00.713
	KEYBOARD 8KB-FV2L WHITE MACLES 84KS WHITE ARABIC/ ENGLISH (LINUX)	KB.INT00.738
	KEYBOARD 8KB-FV2L WHITE MACLES 84KS WHITE US INTERNATIONAL (LINUX)	KB.INT00.706
	KEYBOARD 8KB-FV2L WHITE MACLES 85KS WHITE SWISS/ G (LINUX)	KB.INT00.711
	KEYBOARD 8KB-FV2L WHITE MACLES 85KS WHITE PORTUGUESE (LINUX)	KB.INT00.717
	KEYBOARD 8KB-FV2L WHITE MACLES 84KS WHITE US INTERNATIONAL HEBREW (LINUX)	KB.INT00.707
	KEYBOARD 8KB-FV2L WHITE MACLES 85KS WHITE NORWEGIAN (LINUX)	KB.INT00.719
	KEYBOARD 8KB-FV2L WHITE MACLES 84KS WHITE KOREAN (LINUX)	KB.INT00.721
LCD		
	LED LCD AUO 8.9" WSVGA Glare A089SW01 V0 G5 LF 180nit 30ms	LK.08905.002
	LED LCD CMO 8.9" WSVGA Glare N089L6-L02 LF 180nit 16ms	LK.0890D.001
Mainboard		
	MAINBOARD INTEL 945GSE CPU 1.6G RAM 512MB W/SD READER FOR SSD	MB.S0306.001
	MAINBOARD INTEL 945GSE CPU 1.6G RAM 512MB W/SD READER FOR HDD	MB.S0506.001
Memory		
	Memory HYNIX SO-DIMM DDRII 667 512MB HYMP164S64CP6-Y5 LF	KN.5120G.024
	Memory SAMSUNG SO-DIMM DDRII 667 512MB M470T6464QZ3-CE6 LF	KN.5120B.026
	Memory HYNIX SO-DIMM DDRII 667 1GB HYMP112S64CP6-Y5 LF	KN.1GB0G.012
	Memory SAMSUNG SO-DIMM DDRII 667 1GB M470T2864QZ3-CE6 LF	KN.1GB0B.016
Heatsink		
	THERMAL MODULE	60.S0207.005

Category	Description	Part No.
Miscellaneous		
	LCD BEZEL RUBBER	47.S0207.001
	LCD BEZEL MYLAR	47.S0207.002
	RUBBER FOOT	47.S0207.003

Screw List

Item	Description	Part No.
SCREW	SCREW M2.5*4.0-I(NI)(NYLOK)	86.D01V7.001
SCREW	SCREW M2.0*3.0-I(NI)(NYLOK)	86.TDY07.002
SCREW	SCREW M2.0*3.0-I IRON	86.S0207.001
SCREW	SCREW 2.0*4.0	86.W0107.003
SCREW	SCREW M2*5-I(BZN)(NYLOK)	86.TG607.004
SCREW	SCREW M2.0*5.0-I(NI)	86.S0207.002
SCREW	SCREW M3*0.5+3.5I	86.TDY07.003

Model Definition and Configuration

Aspire one Series

Aspire one Blue

Model	RO	Country	Acer Part No	Description	CPU
AOA150-Bb	WW	WW	S2.S050B.001	AOA150-Bb AOXPHSTWW1 MC UMACb 2*512/80/6L/5R/CB_bg_0.3D_GE_EN11_C1 (TW)	ATMN270B
AOA150-Ab	WW	WW	S2.S050A.001	AOA150-Ab AOLINXSWW1 UMACb 2*512/80/6L/5R/CB_bg_0.3D_GE_EN11_C1 (TW)	ATMN270B
AOA150-Ab	EMEA	Germany	LU.S050A.050	AOA150-Ab AOLINXSDE1 UMACb 2*512/80/3L/5R/CB_bg_0.3D_BAG_GE_IT31	ATMN270B
AOA150-Ab	EMEA	Eastern Europe	LU.S050A.048	AOA150-Ab AOLINXSEU4 UMACb 2*512/80/3L/5R/CB_bg_0.3D_BAG_GE_EN81	ATMN270B
AOA150-Ab	EMEA	Denmark	LU.S050A.046	AOA150-Ab AOLINXSDK1 UMACb 2*512/80/3L/5R/CB_bg_0.3D_BAG_GE_DA11	ATMN270B
AOA150-Ab	EMEA	Sweden/Finland	LU.S050A.047	AOA150-Ab AOLINXSSE1 UMACb 2*512/80/3L/5R/CB_bg_0.3D_BAG_GE_EN81	ATMN270B
AOA150-Ab	EMEA	Holland	LU.S050A.052	AOA150-Ab AOLINXSNL1 UMACb 2*512/80/3L/5R/CB_bg_0.3D_BAG_GE_NL11	ATMN270B
AOA150-Ab	EMEA	France	LU.S050A.049	AOA150-Ab AOLINXSFR1 UMACb 2*512/80/3L/5R/CB_bg_0.3D_BAG_GE_IT31	ATMN270B
AOA150-Ab	EMEA	South Africa	LU.S050A.044	AOA150-Ab AOLINXSZA2 UMACb 2*512/80/3L/5R/CB_bg_0.3D_BAG_GE_EN11	ATMN270B
AOA150-Ab	EMEA	Luxembourg	LU.S050A.051	AOA150-Ab AOLINXSLU1 UMACb 2*512/80/3L/5R/CB_bg_0.3D_BAG_GE_IT41	ATMN270B
AOA150-Ab	EMEA	Belgium	LU.S050A.053	AOA150-Ab AOLINXSBE1 UMACb 2*512/80/3L/5R/CB_bg_0.3D_BAG_GE_NL11	ATMN270B
AOA150-Ab	EMEA	South Africa	LU.S050A.045	AOA150-Ab AOLINXSZA1 UMACb 2*512/80/3L/5R/CB_bg_0.3D_BAG_GE_FR51	ATMN270B
AOA150-Ab	EMEA	Czech	LU.S050A.056	AOA150-Ab AOLINXSCZ2 UMACb 2*512/80/3L/5R/CB_bg_0.3D_BAG_GE_EN21	ATMN270B
AOA150-Ab	EMEA	Middle East	LU.S050A.068	AOA150-Ab AOLINXSME9 UMACb 2*512/80/3L/5R/CB_bg_0.3D_BAG_GE_IT31	ATMN270B
AOA150-Ab	EMEA	Eastern Europe	LU.S050A.058	AOA150-Ab AOLINXSEU3 UMACb 2*512/80/3L/5R/CB_bg_0.3D_BAG_GE_RU21	ATMN270B
AOA150-Ab	EMEA	Hungary	LU.S050A.059	AOA150-Ab AOLINXSHU1 UMACb 2*512/80/3L/5R/CB_bg_0.3D_BAG_GE_EN41	ATMN270B
AOA150-Ab	EMEA	Middle East	LU.S050A.070	AOA150-Ab AOLINXSME4 UMACb 2*512/80/3L/5R/CB_bg_0.3D_BAG_GE_EN11	ATMN270B
AOA150-Ab	EMEA	Spain	LU.S050A.063	AOA150-Ab AOLINXSES1 UMACb 2*512/80/3L/5R/CB_bg_0.3D_BAG_GE_PT21	ATMN270B
AOA150-Ab	EMEA	Middle East	LU.S050A.071	AOA150-Ab AOLINXSME6 UMACb 2*512/80/3L/5R/CB_bg_0.3D_BAG_GE_EN11	ATMN270B
AOA150-Ab	EMEA	Portugal	LU.S050A.062	AOA150-Ab AOLINXSPT1 UMACb 2*512/80/3L/5R/CB_bg_0.3D_BAG_GE_PT21	ATMN270B
AOA150-Ab	EMEA	Greece	LU.S050A.067	AOA150-Ab AOLINXSGR1 UMACb 2*512/80/3L/5R/CB_bg_0.3D_BAG_GE_EL41	ATMN270B
AOA150-Ab	EMEA	Norway	LU.S050A.054	AOA150-Ab AOLINXSNO1 UMACb 2*512/80/3L/5R/CB_bg_0.3D_BAG_GE_DA11	ATMN270B
AOA150-Ab	EMEA	Italy	LU.S050A.066	AOA150-Ab AOLINXSIT1 UMACb 2*512/80/3L/5R/CB_bg_0.3D_BAG_GE_IT31	ATMN270B
AOA150-Ab	EMEA	Turkey	LU.S050A.065	AOA150-Ab AOLINXSTR1 UMACb 2*512/80/3L/5R/CB_bg_0.3D_BAG_GE_TR51	ATMN270B

Model	RO	Country	Acer Part No	Description	CPU
AOA150-Ab	EMEA	Russia	LU.S050A.055	AOA150-Ab AOLINXSRU1 UMACb 2*512/80/3L/5R/CB_bg_0.3D_BAG_GE_RU21	ATMN270B
AOA150-Ab	EMEA	Eastern Europe	LU.S050A.057	AOA150-Ab AOLINXSEU6 UMACb 2*512/80/3L/5R/CB_bg_0.3D_BAG_GE_EN21	ATMN270B
AOA150-Ab	EMEA	Slovenia/Croatia	LU.S050A.061	AOA150-Ab AOLINXSS11 UMACb 2*512/80/3L/5R/CB_bg_0.3D_BAG_GE_EN11	ATMN270B
AOA150-Ab	EMEA	Switzerland	LU.S050A.073	AOA150-Ab AOLINXSCH1 UMACb 2*512/80/3L/5R/CB_bg_0.3D_BAG_GE_IT41	ATMN270B
AOA150-Ab	EMEA	Middle East	LU.S050A.072	AOA150-Ab AOLINXSME3 UMACb 2*512/80/3L/5R/CB_bg_0.3D_BAG_GE_IT31	ATMN270B
AOA150-Ab	EMEA	Israel	LU.S050A.064	AOA150-Ab AOLINXSIL1 UMACb 2*512/80/3L/5R/CB_bg_0.3D_BAG_GE_EN11	ATMN270B
AOA150-Ab	EMEA	Eastern Europe	LU.S050A.060	AOA150-Ab AOLINXSEU5 UMACb 2*512/80/3L/5R/CB_bg_0.3D_BAG_GE_EN41	ATMN270B
AOA150-Ab	EMEA	Middle East	LU.S050A.069	AOA150-Ab AOLINXSME2 UMACb 2*512/80/3L/5R/CB_bg_0.3D_BAG_GE_EN11	ATMN270B
AOA150-Bb	EMEA	France	LU.S050B.042	AOA150-Bb AOXPSTFR1 MC UMACb 1*512/80/3L/5R/CB_bg_0.3D_BAG_GE_FR22	ATMN270B
AOA150-Ab	EMEA	Middle East	LU.S050A.099	AOA150-Ab AOLINXSME9 UMACb 1*512/80/3L/5R/CB_bg_0.3D_BAG_GE_IT31	ATMN270B
AOA150-Bb	EMEA	Luxembourg	LU.S050B.046	AOA150-Bb AOXPSTLU1 MC UMACb 1*512/80/3L/5R/CB_bg_0.3D_BAG_GE_IT42	ATMN270B
AOA150-Ab	EMEA	Middle East	LU.S050A.101	AOA150-Ab AOLINXSME4 UMACb 1*512/80/3L/5R/CB_bg_0.3D_BAG_GE_EN11	ATMN270B
AOA150-Bb	EMEA	Holland	LU.S050B.044	AOA150-Bb AOXPSTNL1 MC UMACb 1*512/80/3L/5R/CB_bg_0.3D_BAG_GE_NL12	ATMN270B
AOA150-Ab	EMEA	Middle East	LU.S050A.102	AOA150-Ab AOLINXSME6 UMACb 1*512/80/3L/5R/CB_bg_0.3D_BAG_GE_EN11	ATMN270B
AOA150-Ab	EMEA	Spain	LU.S050A.094	AOA150-Ab AOLINXSES1 UMACb 1*512/80/3L/5R/CB_bg_0.3D_BAG_GE_PT21	ATMN270B
AOA150-Ab	EMEA	Middle East	LU.S050A.103	AOA150-Ab AOLINXSME3 UMACb 1*512/80/3L/5R/CB_bg_0.3D_BAG_GE_IT31	ATMN270B
AOA150-Bb	EMEA	Belgium	LU.S050B.045	AOA150-Bb AOXPSTBE1 MC UMACb 1*512/80/3L/5R/CB_bg_0.3D_BAG_GE_NL12	ATMN270B
AOA150-Ab	EMEA	Switzerland	LU.S050A.104	AOA150-Ab AOLINXSCH1 UMACb 1*512/80/3L/5R/CB_bg_0.3D_BAG_GE_IT41	ATMN270B
AOA150-Ab	EMEA	Turkey	LU.S050A.096	AOA150-Ab AOLINXSTR1 UMACb 1*512/80/3L/5R/CB_bg_0.3D_BAG_GE_TR51	ATMN270B
AOA150-Ab	EMEA	UK	LU.S050A.105	AOA150-Ab AOLINXSGB1 UMACb 1*512/80/3L/5R/CB_bg_0.3D_BAG_GE_EN11	ATMN270B
AOA150-Ab	EMEA	Greece	LU.S050A.098	AOA150-Ab AOLINXSGR1 UMACb 1*512/80/3L/5R/CB_bg_0.3D_BAG_GE_EL41	ATMN270B
AOA150-Bb	EMEA	South Africa	LU.S050B.039	AOA150-Bb AOXPSTZA1 MC UMACb 1*512/80/3L/5R/CB_bg_0.3D_BAG_GE_FR22	ATMN270B
AOA150-Ab	EMEA	Italy	LU.S050A.097	AOA150-Ab AOLINXSIT1 UMACb 1*512/80/3L/5R/CB_bg_0.3D_BAG_GE_IT31	ATMN270B
AOA150-Ab	EMEA	Middle East	LU.S050A.100	AOA150-Ab AOLINXSME2 UMACb 1*512/80/3L/5R/CB_bg_0.3D_BAG_GE_EN11	ATMN270B
AOA150-Bb	EMEA	Germany	LU.S050B.043	AOA150-Bb AOXPSTDE1 MC UMACb 1*512/80/3L/5R/CB_bg_0.3D_BAG_GE_DE12	ATMN270B
AOA150-Bb	EMEA	South Africa	LU.S050B.040	AOA150-Bb AOXPSTZA2 MC UMACb 1*512/80/3L/5R/CB_bg_0.3D_BAG_GE_EN12	ATMN270B
AOA150-Bb	EMEA	Denmark	LU.S050B.041	AOA150-Bb AOXPSTDK1 MC UMACb 1*512/80/3L/5R/CB_bg_0.3D_BAG_GE_NO12	ATMN270B
AOA150-Ab	EMEA	Israel	LU.S050A.095	AOA150-Ab AOLINXSIL1 UMACb 1*512/80/3L/5R/CB_bg_0.3D_BAG_GE_EN11	ATMN270B
AOA150-Ab	EMEA	Denmark	LU.S050A.077	AOA150-Ab AOLINXSDK1 UMACb 1*512/80/3L/5R/CB_bg_0.3D_BAG_GE_DA11	ATMN270B
AOA150-Ab	EMEA	Norway	LU.S050A.088	AOA150-Ab AOLINXSN01 UMACb 1*512/80/3L/5R/CB_bg_0.3D_BAG_GE_DA11	ATMN270B
AOA150-Ab	EMEA	South Africa	LU.S050A.076	AOA150-Ab AOLINXSZA1 UMACb 1*512/80/3L/5R/CB_bg_0.3D_BAG_GE_FR51	ATMN270B

Model	RO	Country	Acer Part No	Description	CPU
AOA150-Ab	EMEA	Portugal	LU.S050A.093	AOA150-Ab AOLINXSP1 UMACb 1*512/80/3L/5R/CB_bg_0.3D_BAG_GE_PT21	ATMN270B
AOA150-Ab	EMEA	Eastern Europe	LU.S050A.081	AOA150-Ab AOLINXSEU4 UMACb 1*512/80/3L/5R/CB_bg_0.3D_BAG_GE_EN81	ATMN270B
AOA150-Ab	EMEA	Germany	LU.S050A.079	AOA150-Ab AOLINXSE1 UMACb 1*512/80/3L/5R/CB_bg_0.3D_BAG_GE_IT31	ATMN270B
AOA150-Ab	EMEA	Sweden/Finland	LU.S050A.080	AOA150-Ab AOLINXSE1 UMACb 1*512/80/3L/5R/CB_bg_0.3D_BAG_GE_EN81	ATMN270B
AOA150-Ab	EMEA	Czech	LU.S050A.082	AOA150-Ab AOLINXSC22 UMACb 1*512/80/3L/5R/CB_bg_0.3D_BAG_GE_EN21	ATMN270B
AOA150-Ab	EMEA	Eastern Europe	LU.S050A.083	AOA150-Ab AOLINXSEU6 UMACb 1*512/80/3L/5R/CB_bg_0.3D_BAG_GE_EN21	ATMN270B
AOA150-Ab	EMEA	Eastern Europe	LU.S050A.084	AOA150-Ab AOLINXSEU3 UMACb 1*512/80/3L/5R/CB_bg_0.3D_BAG_GE_RU21	ATMN270B
AOA150-Ab	EMEA	Hungary	LU.S050A.090	AOA150-Ab AOLINXSHU1 UMACb 1*512/80/3L/5R/CB_bg_0.3D_BAG_GE_EN41	ATMN270B
AOA150-Ab	EMEA	Luxembourg	LU.S050A.085	AOA150-Ab AOLINXSLU1 UMACb 1*512/80/3L/5R/CB_bg_0.3D_BAG_GE_IT41	ATMN270B
AOA150-Ab	EMEA	Eastern Europe	LU.S050A.091	AOA150-Ab AOLINXSEU5 UMACb 1*512/80/3L/5R/CB_bg_0.3D_BAG_GE_EN41	ATMN270B
AOA150-Ab	EMEA	UK	LU.S050A.074	AOA150-Ab AOLINXSGB1 UMACb 2*512/80/3L/5R/CB_bg_0.3D_BAG_GE_EN11	ATMN270B
AOA150-Ab	EMEA	South Africa	LU.S050A.075	AOA150-Ab AOLINXSA2 UMACb 1*512/80/3L/5R/CB_bg_0.3D_BAG_GE_EN11	ATMN270B
AOA150-Ab	EMEA	France	LU.S050A.078	AOA150-Ab AOLINXFR1 UMACb 1*512/80/3L/5R/CB_bg_0.3D_BAG_GE_IT31	ATMN270B
AOA150-Ab	EMEA	Holland	LU.S050A.086	AOA150-Ab AOLINXSNL1 UMACb 1*512/80/3L/5R/CB_bg_0.3D_BAG_GE_NL11	ATMN270B
AOA150-Ab	EMEA	Russia	LU.S050A.089	AOA150-Ab AOLINXSRU1 UMACb 1*512/80/3L/5R/CB_bg_0.3D_BAG_GE_RU21	ATMN270B
AOA150-Ab	EMEA	Slovenia/Croatia	LU.S050A.092	AOA150-Ab AOLINXSS1 UMACb 1*512/80/3L/5R/CB_bg_0.3D_BAG_GE_EN11	ATMN270B
AOA150-Ab	EMEA	Belgium	LU.S050A.087	AOA150-Ab AOLINXSBE1 UMACb 1*512/80/3L/5R/CB_bg_0.3D_BAG_GE_NL11	ATMN270B
AOA150-Bb	EMEA	France	LU.S050B.076	AOA150-Bb AOXPSTFR1 MC UMACb 2*512/80/3L/5R/CB_bg_0.3D_BAG_GE_FR22	ATMN270B
AOA150-Bb	EMEA	Luxembourg	LU.S050B.083	AOA150-Bb AOXPSTLU1 MC UMACb 2*512/80/3L/5R/CB_bg_0.3D_BAG_GE_IT42	ATMN270B
AOA150-Bb	EMEA	Russia	LU.S050B.085	AOA150-Bb AOXPSTRU1 MC UMACb 2*512/80/3L/5R/CB_bg_0.3D_BAG_GE_RU12	ATMN270B
AOA150-Bb	EMEA	Denmark	LU.S050B.075	AOA150-Bb AOXPSTDK1 MC UMACb 2*512/80/3L/5R/CB_bg_0.3D_BAG_GE_NO12	ATMN270B
AOA150-Bb	EMEA	South Africa	LU.S050B.074	AOA150-Bb AOXPSTZA2 MC UMACb 2*512/80/3L/5R/CB_bg_0.3D_BAG_GE_EN12	ATMN270B
AOA150-Bb	EMEA	Belgium	LU.S050B.082	AOA150-Bb AOXPSTBE1 MC UMACb 2*512/80/3L/5R/CB_bg_0.3D_BAG_GE_NL12	ATMN270B
AOA150-Bb	EMEA	Switzerland	LU.S050B.071	AOA150-Bb AOXPSTCH1 MC UMACb 1*512/80/3L/5R/CB_bg_0.3D_BAG_GE_IT42	ATMN270B
AOA150-Bb	EMEA	Eastern Europe	LU.S050B.086	AOA150-Bb AOXPSTEU6 MC UMACb 2*512/80/3L/5R/CB_bg_0.3D_BAG_GE_CS22	ATMN270B
AOA150-Bb	EMEA	Germany	LU.S050B.080	AOA150-Bb AOXPSTDE1 MC UMACb 2*512/80/3L/5R/CB_bg_0.3D_BAG_GE_DE12	ATMN270B
AOA150-Bb	EMEA	Middle East	LU.S050B.068	AOA150-Bb AOXPSTME6 MC UMACb 1*512/80/3L/5R/CB_bg_0.3D_BAG_GE_EN12	ATMN270B
AOA150-Bb	EMEA	Middle East	LU.S050B.070	AOA150-Bb AOXPSTME2 MC UMACb 1*512/80/3L/5R/CB_bg_0.3D_BAG_GE_AR12	ATMN270B
AOA150-Bb	EMEA	Norway	LU.S050B.084	AOA150-Bb AOXPSTNO1 MC UMACb 2*512/80/3L/5R/CB_bg_0.3D_BAG_GE_NO12	ATMN270B
AOA150-Bb	EMEA	Eastern Europe	LU.S050B.079	AOA150-Bb AOXPSTEU4 MC UMACb 2*512/80/3L/5R/CB_bg_0.3D_BAG_GE_FI12	ATMN270B
AOA150-Bb	EMEA	South Africa	LU.S050B.073	AOA150-Bb AOXPSTZA1 MC UMACb 2*512/80/3L/5R/CB_bg_0.3D_BAG_GE_FR22	ATMN270B

Model	RO	Country	Acer Part No	Description	CPU
AOA150-Bb	EMEA	Eastern Europe	LU.S050B.078	AOA150-Bb AOXPHSTEU5 MC UMACb 2*512/80/3L/5R/CB_bg_0.3D_BAG_GE_PL12	ATMN270B
AOA150-Bb	EMEA	Sweden/Finland	LU.S050B.077	AOA150-Bb AOXPHSTSE1 MC UMACb 2*512/80/3L/5R/CB_bg_0.3D_BAG_GE_FI12	ATMN270B
AOA150-Bb	EMEA	Holland	LU.S050B.081	AOA150-Bb AOXPHSTNL1 MC UMACb 2*512/80/3L/5R/CB_bg_0.3D_BAG_GE_NL12	ATMN270B
AOA150-Bb	EMEA	Middle East	LU.S050B.067	AOA150-Bb AOXPHSTME2 MC UMACb 1*512/80/3L/5R/CB_bg_0.3D_BAG_GE_EN12	ATMN270B
AOA150-Bb	EMEA	Middle East	LU.S050B.069	AOA150-Bb AOXPHSTME4 MC UMACb 1*512/80/3L/5R/CB_bg_0.3D_BAG_GE_EN12	ATMN270B
AOA150-Bb	EMEA	UK	LU.S050B.072	AOA150-Bb AOXPHSTGB1 MC UMACb 1*512/80/3L/5R/CB_bg_0.3D_BAG_GE_EN12	ATMN270B
AOA150-Bb	EMEA	Middle East	LU.S050B.102	AOA150-Bb AOXPHSTME6 MC UMACb 2*512/80/3L/5R/CB_bg_0.3D_BAG_GE_EN12	ATMN270B
AOA150-Bb	EMEA	Greece	LU.S050B.096	AOA150-Bb AOXPHSTGR1 MC UMACb 2*512/80/3L/5R/CB_bg_0.3D_BAG_GE_EL32	ATMN270B
AOA150-Bb	EMEA	Turkey	LU.S050B.095	AOA150-Bb AOXPHSTTR1 MC UMACb 2*512/80/3L/5R/CB_bg_0.3D_BAG_GE_TR32	ATMN270B
AOA150-Bb	EMEA	Israel	LU.S050B.094	AOA150-Bb AOXPHSTIL1 MC UMACb 2*512/80/3L/5R/CB_bg_0.3D_BAG_GE_HE12	ATMN270B
AOA150-Bb	EMEA	Spain	LU.S050B.093	AOA150-Bb AOXPHSTES1 MC UMACb 2*512/80/3L/5R/CB_bg_0.3D_BAG_GE_ES22	ATMN270B
AOA150-Bb	EMEA	Slovenia/Croatia	LU.S050B.091	AOA150-Bb AOXPHSTSI1 MC UMACb 2*512/80/3L/5R/CB_bg_0.3D_BAG_GE_EN12	ATMN270B
AOA150-Bb	EMEA	Middle East	LU.S050B.101	AOA150-Bb AOXPHSTME2 MC UMACb 2*512/80/3L/5R/CB_bg_0.3D_BAG_GE_EN12	ATMN270B
AOA150-Bb	EMEA	Middle East	LU.S050B.100	AOA150-Bb AOXPHSTME9 MC UMACb 2*512/80/3L/5R/CB_bg_0.3D_BAG_GE_FR22	ATMN270B
AOA150-Bb	EMEA	Middle East	LU.S050B.099	AOA150-Bb AOXPHSTME3 MC UMACb 2*512/80/3L/5R/CB_bg_0.3D_BAG_GE_FR22	ATMN270B
AOA150-Bb	EMEA	Middle East	LU.S050B.098	AOA150-Bb AOXPHSTME2 MC UMACb 2*512/80/3L/5R/CB_bg_0.3D_BAG_GE_AR22	ATMN270B
AOA150-Bb	EMEA	Portugal	LU.S050B.092	AOA150-Bb AOXPHSTPT1 MC UMACb 2*512/80/3L/5R/CB_bg_0.3D_BAG_GE_PT12	ATMN270B
AOA150-Bb	EMEA	Switzerland	LU.S050B.105	AOA150-Bb AOXPHSTCH1 MC UMACb 2*512/80/3L/5R/CB_bg_0.3D_BAG_GE_IT42	ATMN270B
AOA150-Bb	EMEA	Middle East	LU.S050B.104	AOA150-Bb AOXPHSTME2 MC UMACb 2*512/80/3L/5R/CB_bg_0.3D_BAG_GE_AR12	ATMN270B
AOA150-Bb	EMEA	Italy	LU.S050B.097	AOA150-Bb AOXPHSTIT1 MC UMACb 2*512/80/3L/5R/CB_bg_0.3D_BAG_GE_IT12	ATMN270B
AOA150-Bb	EMEA	UK	LU.S050B.106	AOA150-Bb AOXPHSTGB1 MC UMACb 2*512/80/3L/5R/CB_bg_0.3D_BAG_GE_EN12	ATMN270B
AOA150-Bb	EMEA	Hungary	LU.S050B.090	AOA150-Bb AOXPHSTHU1 MC UMACb 2*512/80/3L/5R/CB_bg_0.3D_BAG_GE_HU12	ATMN270B
AOA150-Bb	EMEA	Czech	LU.S050B.089	AOA150-Bb AOXPHSTCZ2 MC UMACb 2*512/80/3L/5R/CB_bg_0.3D_BAG_GE_SK12	ATMN270B
AOA150-Bb	EMEA	Eastern Europe	LU.S050B.088	AOA150-Bb AOXPHSTEU3 MC UMACb 2*512/80/3L/5R/CB_bg_0.3D_BAG_GE_RU12	ATMN270B
AOA150-Bb	EMEA	Eastern Europe	LU.S050B.087	AOA150-Bb AOXPHSTEU3 MC UMACb 2*512/80/3L/5R/CB_bg_0.3D_BAG_GE_RU22	ATMN270B
AOA150-Bb	EMEA	Middle East	LU.S050B.103	AOA150-Bb AOXPHSTME4 MC UMACb 2*512/80/3L/5R/CB_bg_0.3D_BAG_GE_EN12	ATMN270B
AOA150-Bb	EMEA	Eastern Europe	LU.S050B.051	AOA150-Bb AOXPHSTEU3 MC UMACb 1*512/80/3L/5R/CB_bg_0.3D_BAG_GE_RU22	ATMN270B
AOA150-Bb	EMEA	Eastern Europe	LU.S050B.052	AOA150-Bb AOXPHSTEU3 MC UMACb 1*512/80/3L/5R/CB_bg_0.3D_BAG_GE_RU12	ATMN270B
AOA150-Bb	EMEA	Czech	LU.S050B.053	AOA150-Bb AOXPHSTCZ2 MC UMACb 1*512/80/3L/5R/CB_bg_0.3D_BAG_GE_SK12	ATMN270B
AOA150-Bb	EMEA	Hungary	LU.S050B.056	AOA150-Bb AOXPHSTHU1 MC UMACb 1*512/80/3L/5R/CB_bg_0.3D_BAG_GE_HU12	ATMN270B
AOA150-Bb	EMEA	Italy	LU.S050B.063	AOA150-Bb AOXPHSTIT1 MC UMACb 1*512/80/3L/5R/CB_bg_0.3D_BAG_GE_IT12	ATMN270B

Model	RO	Country	Acer Part No	Description	CPU
AOA150-Bb	EMEA	Portugal	LU.S050B.058	AOA150-Bb AOXPHSTPT1 MC UMACb 1*512/80/3L/5R/CB_bg_0.3D_BAG_GE_PT12	ATMN270B
AOA150-Bb	EMEA	Middle East	LU.S050B.064	AOA150-Bb AOXPHSTME2 MC UMACb 1*512/80/3L/5R/CB_bg_0.3D_BAG_GE_AR22	ATMN270B
AOA150-Bb	EMEA	Middle East	LU.S050B.065	AOA150-Bb AOXPHSTME3 MC UMACb 1*512/80/3L/5R/CB_bg_0.3D_BAG_GE_FR22	ATMN270B
AOA150-Bb	EMEA	Middle East	LU.S050B.066	AOA150-Bb AOXPHSTME9 MC UMACb 1*512/80/3L/5R/CB_bg_0.3D_BAG_GE_FR22	ATMN270B
AOA150-Bb	EMEA	Sweden/Finland	LU.S050B.047	AOA150-Bb AOXPHSTSE1 MC UMACb 1*512/80/3L/5R/CB_bg_0.3D_BAG_GE_FI12	ATMN270B
AOA150-Bb	EMEA	Eastern Europe	LU.S050B.048	AOA150-Bb AOXPHSTEU5 MC UMACb 1*512/80/3L/5R/CB_bg_0.3D_BAG_GE_PL12	ATMN270B
AOA150-Bb	EMEA	Eastern Europe	LU.S050B.049	AOA150-Bb AOXPHSTEU4 MC UMACb 1*512/80/3L/5R/CB_bg_0.3D_BAG_GE_FI12	ATMN270B
AOA150-Bb	EMEA	Norway	LU.S050B.054	AOA150-Bb AOXPHSTNO1 MC UMACb 1*512/80/3L/5R/CB_bg_0.3D_BAG_GE_NO12	ATMN270B
AOA150-Bb	EMEA	Slovenia/Croatia	LU.S050B.057	AOA150-Bb AOXPHSTSI1 MC UMACb 1*512/80/3L/5R/CB_bg_0.3D_BAG_GE_EN12	ATMN270B
AOA150-Bb	EMEA	Spain	LU.S050B.059	AOA150-Bb AOXPHSTES1 MC UMACb 1*512/80/3L/5R/CB_bg_0.3D_BAG_GE_ES22	ATMN270B
AOA150-Bb	EMEA	Eastern Europe	LU.S050B.050	AOA150-Bb AOXPHSTEU6 MC UMACb 1*512/80/3L/5R/CB_bg_0.3D_BAG_GE_CS22	ATMN270B
AOA150-Bb	EMEA	Israel	LU.S050B.060	AOA150-Bb AOXPHSTIL1 MC UMACb 1*512/80/3L/5R/CB_bg_0.3D_BAG_GE_HE12	ATMN270B
AOA150-Bb	EMEA	Turkey	LU.S050B.061	AOA150-Bb AOXPHSTTR1 MC UMACb 1*512/80/3L/5R/CB_bg_0.3D_BAG_GE_TR32	ATMN270B
AOA150-Bb	EMEA	Russia	LU.S050B.055	AOA150-Bb AOXPHSTRU1 MC UMACb 1*512/80/3L/5R/CB_bg_0.3D_BAG_GE_RU12	ATMN270B
AOA150-Bb	EMEA	Greece	LU.S050B.062	AOA150-Bb AOXPHSTGR1 MC UMACb 1*512/80/3L/5R/CB_bg_0.3D_BAG_GE_EL32	ATMN270B
AOA150-Ab	EMEA	Middle East	LU.S050A.113	AOA150-Ab AOLINXSME9 UMACb 2*512/80/3L/5R/CB_bg_0.3D_BAG_GE_IT31	ATMN270B
AOA150-Ab	EMEA	Spain	LU.S050A.121	AOA150-Ab AOLINXSES1 UMACb 2*512/80/3L/5R/CB_bg_0.3D_BAG_GE_PT21	ATMN270B
AOA150-Ab	EMEA	Eastern Europe	LU.S050A.125	AOA150-Ab AOLINXSEU6 UMACb 2*512/80/3L/5R/CB_bg_0.3D_BAG_GE_EN21	ATMN270B
AOA150-Ab	EMEA	Eastern Europe	LU.S050A.126	AOA150-Ab AOLINXSEU3 UMACb 2*512/80/3L/5R/CB_bg_0.3D_BAG_GE_RU21	ATMN270B
AOA150-Ab	EMEA	Hungary	LU.S050A.124	AOA150-Ab AOLINXSHU1 UMACb 2*512/80/3L/5R/CB_bg_0.3D_BAG_GE_EN41	ATMN270B
AOA150-Ab	EMEA	Middle East	LU.S050A.114	AOA150-Ab AOLINXSME2 UMACb 2*512/80/3L/5R/CB_bg_0.3D_BAG_GE_EN11	ATMN270B
AOA150-Ab	EMEA	Eastern Europe	LU.S050A.127	AOA150-Ab AOLINXSEU5 UMACb 2*512/80/3L/5R/CB_bg_0.3D_BAG_GE_EN41	ATMN270B
AOA150-Ab	EMEA	Israel	LU.S050A.119	AOA150-Ab AOLINXSIL1 UMACb 2*512/80/3L/5R/CB_bg_0.3D_BAG_GE_EN11	ATMN270B
AOA150-Ab	EMEA	Middle East	LU.S050A.115	AOA150-Ab AOLINXSME4 UMACb 2*512/80/3L/5R/CB_bg_0.3D_BAG_GE_EN11	ATMN270B
AOA150-Ab	EMEA	Middle East	LU.S050A.116	AOA150-Ab AOLINXSME6 UMACb 2*512/80/3L/5R/CB_bg_0.3D_BAG_GE_EN11	ATMN270B
AOA150-Ab	EMEA	Middle East	LU.S050A.110	AOA150-Ab AOLINXSME3 UMACb 2*512/80/3L/5R/CB_bg_0.3D_BAG_GE_IT31	ATMN270B
AOA150-Ab	EMEA	Switzerland	LU.S050A.112	AOA150-Ab AOLINXSCH1 UMACb 2*512/80/3L/5R/CB_bg_0.3D_BAG_GE_IT41	ATMN270B
AOA150-Ab	EMEA	UK	LU.S050A.111	AOA150-Ab AOLINXSGB1 UMACb 2*512/80/3L/5R/CB_bg_0.3D_BAG_GE_EN11	ATMN270B
AOA150-Ab	EMEA	Russia	LU.S050A.129	AOA150-Ab AOLINXSRU1 UMACb 2*512/80/3L/5R/CB_bg_0.3D_BAG_GE_RU21	ATMN270B
AOA150-Ab	EMEA	Slovenia/Croatia	LU.S050A.123	AOA150-Ab AOLINXSS1 UMACb 2*512/80/3L/5R/CB_bg_0.3D_BAG_GE_EN11	ATMN270B
AOA150-Ab	EMEA	Turkey	LU.S050A.117	AOA150-Ab AOLINXSTR1 UMACb 2*512/80/3L/5R/CB_bg_0.3D_BAG_GE_TR51	ATMN270B

Model	RO	Country	Acer Part No	Description	CPU
AOA150-Ab	EMEA	Italy	LU.S050A.118	AOA150-Ab AOLINXSIT1 UMACb 2*512/80/3L/5R/CB_bg_0.3D_BAG_GE_IT31	ATMN270B
AOA150-Ab	EMEA	Norway	LU.S050A.130	AOA150-Ab AOLINXSNO1 UMACb 2*512/80/3L/5R/CB_bg_0.3D_BAG_GE_DA11	ATMN270B
AOA150-Ab	EMEA	Greece	LU.S050A.120	AOA150-Ab AOLINXSGR1 UMACb 2*512/80/3L/5R/CB_bg_0.3D_BAG_GE_EL41	ATMN270B
AOA150-Ab	EMEA	Portugal	LU.S050A.122	AOA150-Ab AOLINXSPT1 UMACb 2*512/80/3L/5R/CB_bg_0.3D_BAG_GE_PT21	ATMN270B
AOA150-Ab	EMEA	Czech	LU.S050A.128	AOA150-Ab AOLINXSCZ2 UMACb 2*512/80/3L/5R/CB_bg_0.3D_BAG_GE_EN21	ATMN270B
AOA150-Bb	WW	WW	S2.S050B.002	AOA150-Bb AOXPSTWW1 MC UMACb 2*512/80/6L/5R/CB_bg_0.3D_BAG_GE_EN11	ATMN270B
AOA150-Ab	AAP	Indonesia	LU.S050A.016	AOA150-Ab AOLINXSID1 UMACb 2*512/120/6L/5R/CB_bg_0.3D_BAG_GE_EN11	ATMN270B
AOA150-Ab	AAP	Indonesia	LU.S050A.017	AOA150-Ab AOLINXSID1 UMACb 2*512/120/6L/5R/CB_bg_0.3D_BAG_GE_ID21	ATMN270B
AOA150-Ab	AAP	Japan	LU.S050A.018	AOA150-Ab AOLINXSJP1 UMACb 2*512/120/6L/5R/CB_bg_0.3D_BAG_GE_JA11	ATMN270B
AOA150-Ab	AAP	India	LU.S050A.015	AOA150-Ab AOLINXSIN1 UMACb 2*512/120/6L/5R/CB_bg_0.3D_BAG_GE_EN11	ATMN270B
AOA150-Ab	AAP	Singapore	LU.S050A.012	AOA150-Ab AOLINXSSG1 UMACb 2*512/120/6L/5R/CB_bg_0.3D_BAG_GE_EN11	ATMN270B
AOA150-Ab	AAP	Malaysia	LU.S050A.020	AOA150-Ab AOLINXSMY1 UMACb 2*512/120/6L/5R/CB_bg_0.3D_BAG_GE_EN11	ATMN270B
AOA150-Ab	AAP	Australia/ New Zealand	LU.S050A.011	AOA150-Ab AOLINXSAU1 UMACb 2*512/120/3L/5R/CB_bg_0.3D_BAG_GE_EN11	ATMN270B
AOA150-Ab	AAP	Singapore	LU.S050A.014	AOA150-Ab AOLINXSSG1 UMACb 2*512/120/6L/5R/CB_bg_0.3D_BAG_GE_ZH31	ATMN270B
AOA150-Ab	AAP	Philippines	LU.S050A.019	AOA150-Ab AOLINXSPH1 UMACb 2*512/120/6L/5R/CB_bg_0.3D_BAG_GE_EN11	ATMN270B
AOA150-Ab	AAP	Vietnam	LU.S050A.013	AOA150-Ab AOLINXSVN1 UMACb 2*512/120/6L/5R/CB_bg_0.3D_BAG_GE_EN11	ATMN270B
AOA150-Bb	AAP	Indonesia	LU.S050B.037	AOA150-Bb AOXPSTID1 MC UMACb 1*512/120/6L/5R/CB_bg_N_BAG_GE_ID21	ATMN270B
AOA150-Bb	AAP	Indonesia	LU.S050B.036	AOA150-Bb AOXPSTID1 MC UMACb 1*512/120/6L/5R/CB_bg_N_BAG_GE_EN11	ATMN270B
AOA150-Bb	AAP	Japan	LU.S050B.115	AOA150-Bb AOXPSTJP1 MC UMACb 2*512/120/3L/5R/CB_bg_0.3D_BAG_GE_JA11	ATMN270B
AOA150-Bb	AAP	Japan	LU.S050B.038	AOA150-Bb AOXPSTJP1 MC UMACb 1*512/120/6L/5R/CB_bg_N_BAG_GE_JA11	ATMN270B
AOA150-Ab	AAP	Singapore	LU.S050A.024	AOA150-Ab AOLINXSSG1 UMACb 1*512/120/6L/5R/CB_bg_0.3D_BAG_GE_ZH31	ATMN270B
AOA150-Ab	AAP	Singapore	LU.S050A.023	AOA150-Ab AOLINXSSG1 UMACb 1*512/120/6L/5R/CB_bg_0.3D_BAG_GE_EN11	ATMN270B
AOA150-Ab	AAP	Indonesia	LU.S050A.026	AOA150-Ab AOLINXSID1 UMACb 1*512/120/6L/5R/CB_bg_0.3D_BAG_GE_EN11	ATMN270B
AOA150-Ab	AAP	Indonesia	LU.S050A.027	AOA150-Ab AOLINXSID1 UMACb 1*512/120/6L/5R/CB_bg_0.3D_BAG_GE_ID21	ATMN270B
AOA150-Ab	AAP	Australia/ New Zealand	LU.S050A.022	AOA150-Ab AOLINXSAU1 UMACb 1*512/120/3L/5R/CB_bg_0.3D_BAG_GE_EN11	ATMN270B
AOA150-Ab	AAP	Philippines	LU.S050A.029	AOA150-Ab AOLINXSPH1 UMACb 1*512/120/6L/5R/CB_bg_0.3D_BAG_GE_EN11	ATMN270B
AOA150-Ab	AAP	Vietnam	LU.S050A.030	AOA150-Ab AOLINXSVN1 UMACb 1*512/120/6L/5R/CB_bg_0.3D_BAG_GE_EN11	ATMN270B
AOA150-Ab	AAP	Japan	LU.S050A.028	AOA150-Ab AOLINXSJP1 UMACb 1*512/120/6L/5R/CB_bg_0.3D_BAG_GE_JA11	ATMN270B
AOA150-Ab	AAP	India	LU.S050A.025	AOA150-Ab AOLINXSIN1 UMACb 1*512/120/6L/5R/CB_bg_0.3D_BAG_GE_EN11	ATMN270B
AOA150-Ab	AAP	Thailand	LU.S050A.021	AOA150-Ab AOLINXSTH1 UMACb 2*512/120/6L/5R/CB_bg_0.3D_BAG_GE_TH21	ATMN270B

Model	RO	Country	Acer Part No	Description	CPU
AOA150-Ab	AAP	Indonesia	LU.S050A.037	AOA150-Ab AOLINXSID1 UMACb 512+1G/120/6L/5R/CB_bg_0.3D_BAG_GE_EN11	ATMN270B
AOA150-Ab	AAP	Thailand	LU.S050A.032	AOA150-Ab AOLINXSTH1 UMACb 1*512/120/6L/5R/CB_bg_0.3D_BAG_GE_TH21	ATMN270B
AOA150-Ab	AAP	Philippines	LU.S050A.040	AOA150-Ab AOLINXSPH1 UMACb 512+1G/120/6L/5R/CB_bg_0.3D_BAG_GE_EN11	ATMN270B
AOA150-Ab	AAP	Japan	LU.S050A.039	AOA150-Ab AOLINXJSP1 UMACb 512+1G/120/6L/5R/CB_bg_0.3D_BAG_GE_JA11	ATMN270B
AOA150-Ab	AAP	India	LU.S050A.036	AOA150-Ab AOLINXSIN1 UMACb 512+1G/120/6L/5R/CB_bg_0.3D_BAG_GE_EN11	ATMN270B
AOA150-Ab	AAP	Singapore	LU.S050A.034	AOA150-Ab AOLINXSSG1 UMACb 512+1G/120/6L/5R/CB_bg_0.3D_BAG_GE_EN11	ATMN270B
AOA150-Ab	AAP	Australia/ New Zealand	LU.S050A.033	AOA150-Ab AOLINXSAU1 UMACb 512+1G/120/3L/5R/CB_bg_0.3D_BAG_GE_EN11	ATMN270B
AOA150-Ab	AAP	Indonesia	LU.S050A.038	AOA150-Ab AOLINXSID1 UMACb 512+1G/120/6L/5R/CB_bg_0.3D_BAG_GE_ID21	ATMN270B
AOA150-Ab	AAP	Malaysia	LU.S050A.031	AOA150-Ab AOLINXSMY1 UMACb 1*512/120/6L/5R/CB_bg_0.3D_BAG_GE_EN11	ATMN270B
AOA150-Ab	AAP	Singapore	LU.S050A.035	AOA150-Ab AOLINXSSG1 UMACb 512+1G/120/6L/5R/CB_bg_0.3D_BAG_GE_ZH31	ATMN270B
AOA150-Bb	AAP	Philippines	LU.S050B.015	AOA150-Bb AOXPSTPH1 MC UMACb 2*512/120/6L/5R/CB_bg_0.3D_BAG_GE_EN11	ATMN270B
AOA150-Bb	AAP	Australia/ New Zealand	LU.S050B.009	AOA150-Bb AOXPSTAU1 MC UMACb 2*512/120/3L/5R/CB_bg_0.3D_BAG_GE_EN11	ATMN270B
AOA150-Bb	AAP	India	LU.S050B.011	AOA150-Bb AOXPSTIN1 MC UMACb 2*512/120/6L/5R/CB_bg_0.3D_BAG_GE_EN11	ATMN270B
AOA150-Ab	AAP	Malaysia	LU.S050A.041	AOA150-Ab AOLINXSMY1 UMACb 512+1G/120/6L/5R/CB_bg_0.3D_BAG_GE_EN11	ATMN270B
AOA150-Ab	AAP	Vietnam	LU.S050A.042	AOA150-Ab AOLINXSVN1 UMACb 512+1G/120/6L/5R/CB_bg_0.3D_BAG_GE_EN11	ATMN270B
AOA150-Ab	AAP	Thailand	LU.S050A.043	AOA150-Ab AOLINXSTH1 UMACb 512+1G/120/6L/5R/CB_bg_0.3D_BAG_GE_TH21	ATMN270B
AOA150-Bb	AAP	Japan	LU.S050B.014	AOA150-Bb AOXPSTJP1 MC UMACb 2*512/120/6L/5R/CB_bg_0.3D_BAG_GE_JA11	ATMN270B
AOA150-Bb	AAP	Indonesia	LU.S050B.013	AOA150-Bb AOXPSTID1 MC UMACb 2*512/120/6L/5R/CB_bg_0.3D_BAG_GE_ID21	ATMN270B
AOA150-Bb	AAP	Singapore	LU.S050B.010	AOA150-Bb AOXPSTSG1 MC UMACb 2*512/120/6L/5R/CB_bg_0.3D_BAG_GE_EN11	ATMN270B
AOA150-Bb	AAP	Indonesia	LU.S050B.012	AOA150-Bb AOXPSTID1 MC UMACb 2*512/120/6L/5R/CB_bg_0.3D_BAG_GE_EN11	ATMN270B
AOA150-Bb	AAP	Indonesia	LU.S050B.021	AOA150-Bb AOXPSTID1 MC UMACb 512+1G/120/6L/5R/CB_bg_0.3D_BAG_GE_EN11	ATMN270B
AOA150-Bb	AAP	Indonesia	LU.S050B.022	AOA150-Bb AOXPSTID1 MC UMACb 512+1G/120/6L/5R/CB_bg_0.3D_BAG_GE_ID21	ATMN270B
AOA150-Bb	AAP	Japan	LU.S050B.023	AOA150-Bb AOXPSTJP1 MC UMACb 512+1G/120/6L/5R/CB_bg_0.3D_BAG_GE_JA11	ATMN270B
AOA150-Bb	AAP	India	LU.S050B.020	AOA150-Bb AOXPSTIN1 MC UMACb 512+1G/120/6L/5R/CB_bg_0.3D_BAG_GE_EN11	ATMN270B
AOA150-Bb	AAP	Australia/ New Zealand	LU.S050B.018	AOA150-Bb AOXPSTAU1 MC UMACb 512+1G/120/3L/5R/CB_bg_0.3D_BAG_GE_EN11	ATMN270B
AOA150-Bb	AAP	Philippines	LU.S050B.024	AOA150-Bb AOXPSTPH1 MC UMACb 512+1G/120/6L/5R/CB_bg_0.3D_BAG_GE_EN11	ATMN270B
AOA150-Bb	AAP	Singapore	LU.S050B.019	AOA150-Bb AOXPSTSG1 MC UMACb 512+1G/120/6L/5R/CB_bg_0.3D_BAG_GE_EN11	ATMN270B

Model	RO	Country	Acer Part No	Description	CPU
AOA150-Bb	AAP	Malaysia	LU.S050B.025	AOA150-Bb AOXPHESTMY1 MC UMACb 512+1G/120/6L/5R/ CB_bg_0.3D_BAG_GE_EN11	ATMN270B
AOA150-Bb	AAP	Malaysia	LU.S050B.016	AOA150-Bb AOXPHESTMY1 MC UMACb 2*512/ 120/6L/5R/CB_bg_0.3D_BAG_GE_EN11	ATMN270B
AOA150-Bb	AAP	Thailand	LU.S050B.017	AOA150-Bb AOXPHESTTH1 MC UMACb 2*512/ 120/6L/5R/CB_bg_0.3D_BAG_GE_TH21	ATMN270B
AOA150-Bb	AAP	Thailand	LU.S050B.032	AOA150-Bb AOXPHESTTH1 MC UMACb 1*512/ 120/6L/5R/CB_bg_N_BAG_GE_TH21	ATMN270B
AOA150-Bb	AAP	Malaysia	LU.S050B.031	AOA150-Bb AOXPHESTMY1 MC UMACb 1*512/ 120/6L/5R/CB_bg_N_BAG_GE_EN11	ATMN270B
AOA150-Bb	AAP	India	LU.S050B.035	AOA150-Bb AOXPHESTIN1 MC UMACb 1*512/ 120/6L/5R/CB_bg_N_BAG_GE_EN11	ATMN270B
AOA150-Bb	AAP	Philippines	LU.S050B.030	AOA150-Bb AOXPHESTPH1 MC UMACb 1*512/ 120/6L/5R/CB_bg_N_BAG_GE_EN11	ATMN270B
AOA150-Bb	AAP	Singapore	LU.S050B.029	AOA150-Bb AOXPHESTSG1 MC UMACb 1*512/ 120/6L/5R/CB_bg_N_BAG_GE_EN11	ATMN270B
AOA150-Bb	AAP	Vietnam	LU.S050B.026	AOA150-Bb AOXPHESTVN1 MC UMACb 2*512/ 120/6L/5R/CB_bg_0.3D_BAG_GE_EN11	ATMN270B
AOA150-Bb	AAP	Thailand	LU.S050B.027	AOA150-Bb AOXPHESTTH1 MC UMACb 512+1G/120/6L/5R/ CB_bg_0.3D_BAG_GE_TH21	ATMN270B
AOA150-Bb	AAP	Australia/ New Zealand	LU.S050B.034	AOA150-Bb AOXPHESTAU1 MC UMACb 1*512/ 120/3L/5R/CB_bg_N_BAG_GE_EN11	ATMN270B
AOA150-Bb	AAP	Vietnam	LU.S050B.033	AOA150-Bb AOXPHESTVN1 MC UMACb 1*512/ 120/6L/5R/CB_bg_N_BAG_GE_EN11	ATMN270B
AOA150-Bb	AAP	Vietnam	LU.S050B.028	AOA150-Bb AOXPHESTVN1 MC UMACb 512+1G/120/6L/5R/ CB_bg_0.3D_BAG_GE_EN11	ATMN270B
AOA150-Ab	TWN	GCTWN	LU.S050A.005	AOA150-Ab AOLINXSTW1 UMACb 512+1G/ 120/6L/5R/CB_bg_0.3D_BAG_GE_TC21	ATMN270B
AOA150-Bb	TWN	GCTWN	LU.S050B.110	AOA150-Bb AOXPHESTTW1 MC UMACb 2*512/ 120/3L/5R/CB_bg_0.3D_BAG_GE_TC11	ATMN270B
AOA150-Bb	TWN	GCTWN	LU.S050B.008	AOA150-Bb AOXPHESTTW1 MC UMACb 512+1G/120/6L/5R/ CB_bg_0.3D_BAG_GE_TC11	ATMN270B
AOA150-Ab	TWN	GCTWN	LU.S050A.004	AOA150-Ab AOLINXSTW1 UMACb 512+1G/ 120/6L/5R/CB_bg_0.3D_BAG_GE_TC11	ATMN270B
AOA150-Ab	CHINA	China	LU.S050A.001	AOA150-Ab AOLINXSCN1 UMACb 512+1G/ 120/6L/5R/CB_bg_0.3D_BAG_GE_SC12	ATMN270B
AOA150-Bb	CHINA	China	LU.S050B.006	AOA150-Bb AOXPHESTCN1 MC UMACb 512+1G/120/6L/5R/ CB_bg_0.3D_BAG_GE_SC11	ATMN270B
AOA150-Bb	CHINA	Hong Kong	LU.S050B.007	AOA150-Bb AOXPHESTHK2 MC UMACb 512+1G/120/6L/5R/ CB_bg_0.3D_BAG_GE_ZH31	ATMN270B
AOA150-Ab	CHINA	Hong Kong	LU.S050A.002	AOA150-Ab AOLINXSHK2 UMACb 512+1G/ 120/6L/5R/CB_bg_0.3D_BAG_GE_ZH31	ATMN270B
AOA150-Ab	CHINA	Hong Kong	LU.S050A.003	AOA150-Ab AOLINXSHK2 UMACb 512+1G/ 120/6L/5R/CB_bg_0.3D_BAG_GE_EN91	ATMN270B
AOA150-Ab	PA	ACLA- Spanish	LU.S050A.010	AOA150-Ab AOLINXSEA3 UMACb 2*512/120/ 6L/5R/CB_bg_0.3D_BAG_GE_ES21	ATMN270B
AOA150-Ab	PA	ACLA- Spanish	LU.S050A.107	AOA150-Ab AOLINXSEA3 UMACb 2*512/120/ 3L/5R/CB_bg_0.3D_BAG_GE_ES21	ATMN270B
AOA150-Ab	PA	USA	LU.S050A.106	AOA150-Ab AOLINXSUS1 UMACb 1*512/120/ 3L/5R/CB_bg_0.3D_BAG_GE_EN31	ATMN270B
AOA150-Ab	PA	Canada	LU.S050A.006	AOA150-Ab AOLINXSCA2 UMACb 1*512/120/ 3L/5R/CB_bg_0.3D_BAG_GE_FR31	ATMN270B
AOA150-Ab	PA	ACLA- Spanish	LU.S050A.009	AOA150-Ab AOLINXSEA1 UMACb 2*512/120/ 6L/5R/CB_bg_0.3D_BAG_GE_ES21	ATMN270B
AOA150-Ab	PA	ACLA- Spanish	LU.S050A.108	AOA150-Ab AOLINXSEA1 UMACb 2*512/120/ 3L/5R/CB_bg_0.3D_BAG_GE_ES21	ATMN270B

Model	RO	Country	Acer Part No	Description	CPU
AOA150-Ab	PA	ACLA-Portuguese	LU.S050A.008	AOA150-Ab AOLINXSXC1 UMACb 2*512/120/6L/5R/CB_bg_0.3D_BAG_GE_XC21	ATMN270B
AOA150-Ab	PA	ACLA-Portuguese	LU.S050A.109	AOA150-Ab AOLINXSXC1 UMACb 2*512/120/3L/5R/CB_bg_0.3D_BAG_GE_XC21	ATMN270B
AOA150-Ab	PA	USA	LU.S050A.007	AOA150-Ab AOLINXSUS1 UMACb 2*512/120/6L/5R/CB_bg_0.3D_BAG_GE_EN31	ATMN270B
AOA150-Bb	PA	USA	LU.S050B.001	AOA150-Bb AOXPSTUS1 MC UMACb 512+1G/120/6L/5R/CB_bg_0.3D_BAG_GE_EN31	ATMN270B
AOA150-Ab	AAP	Vietnam	LU.S050A.131	AOA150-Ab AOLINXSVN1 UMACb 512+1G/120/3L/5R/CB_bg_0.3D_BAG_GE_EN11	ATMN270B
AOA150-Bb	PA	USA	LU.S050B.114	AOA150-Bb AOXPSTUS1 MC UMACb 2*512/120/6L/5R/CB_bg_0.3D_BAG_GE_EN31	ATMN270B
AOA150-Bb	PA	ACLA-Portuguese	LU.S050B.004	AOA150-Bb AOXPSTXC1 MC UMACb 512+1G/120/6L/5R/CB_bg_0.3D_BAG_GE_XC21	ATMN270B
AOA150-Bb	PA	Canada	LU.S050B.113	AOA150-Bb AOXPSTCA2 MC UMACb 512+1G/120/3L/5R/CB_bg_0.3D_BAG_GE_FR31	ATMN270B
AOA150-Bb	PA	ACLA-Spanish	LU.S050B.003	AOA150-Bb AOXPSTEA1 MC UMACb 512+1G/120/6L/5R/CB_bg_0.3D_BAG_GE_ES21	ATMN270B
AOA150-Bb	PA	ACLA-Spanish	LU.S050B.107	AOA150-Bb AOXPSTEA3 MC UMACb 2*512/120/3L/5R/CB_bg_0.3D_BAG_GE_ES21	ATMN270B
AOA150-Bb	PA	ACLA-Spanish	LU.S050B.005	AOA150-Bb AOXPSTEA3 MC UMACb 512+1G/120/6L/5R/CB_bg_0.3D_BAG_GE_ES21	ATMN270B
AOA150-Bb	PA	Canada	LU.S050B.112	AOA150-Bb AOXPSTCA2 MC UMACb 2*512/120/3L/5R/CB_bg_0.3D_BAG_GE_FR31	ATMN270B
AOA150-Bb	PA	Canada	LU.S050B.002	AOA150-Bb AOXPSTCA2 MC UMACb 2*512/120/6L/5R/CB_bg_0.3D_BAG_GE_FR31	ATMN270B
AOA150-Bb	PA	ACLA-Spanish	LU.S050B.109	AOA150-Bb AOXPSTEA1 MC UMACb 2*512/120/3L/5R/CB_bg_0.3D_BAG_GE_ES21	ATMN270B
AOA150-Bb	PA	ACLA-Portuguese	LU.S050B.108	AOA150-Bb AOXPSTXC2 MC UMACb 2*512/120/3L/5R/CB_bg_0.3D_BAG_GE_XC21	ATMN270B
AOA150-Bb	PA	USA	LU.S050B.111	AOA150-Bb AOXPSTUS1 MC UMACb 2*512/120/3L/5R/CB_bg_0.3D_BAG_GE_EN31	ATMN270B

Model	LCD	Memory 1	Memory 2	HDD 1 (GB)	Card Reader	Wireless LAN
AOA150-Bb	NLED8.9WSVGAG	CM512MB(1Gbx4)	SO512MBII6	N80GB5.4KS	5 in 1-Build in	3rd WiFi BG
AOA150-Ab	NLED8.9WSVGAG	CM512MB(1Gbx4)	SO512MBII6	N80GB5.4KS	5 in 1-Build in	3rd WiFi BG
AOA150-Ab	NLED8.9WSVGAG	CM512MB(1Gbx4)	SO512MBII6	N80GB5.4KS	5 in 1-Build in	3rd WiFi BG
AOA150-Ab	NLED8.9WSVGAG	CM512MB(1Gbx4)	SO512MBII6	N80GB5.4KS	5 in 1-Build in	3rd WiFi BG
AOA150-Ab	NLED8.9WSVGAG	CM512MB(1Gbx4)	SO512MBII6	N80GB5.4KS	5 in 1-Build in	3rd WiFi BG
AOA150-Ab	NLED8.9WSVGAG	CM512MB(1Gbx4)	SO512MBII6	N80GB5.4KS	5 in 1-Build in	3rd WiFi BG
AOA150-Ab	NLED8.9WSVGAG	CM512MB(1Gbx4)	SO512MBII6	N80GB5.4KS	5 in 1-Build in	3rd WiFi BG
AOA150-Ab	NLED8.9WSVGAG	CM512MB(1Gbx4)	SO512MBII6	N80GB5.4KS	5 in 1-Build in	3rd WiFi BG
AOA150-Ab	NLED8.9WSVGAG	CM512MB(1Gbx4)	SO512MBII6	N80GB5.4KS	5 in 1-Build in	3rd WiFi BG
AOA150-Ab	NLED8.9WSVGAG	CM512MB(1Gbx4)	SO512MBII6	N80GB5.4KS	5 in 1-Build in	3rd WiFi BG
AOA150-Ab	NLED8.9WSVGAG	CM512MB(1Gbx4)	SO512MBII6	N80GB5.4KS	5 in 1-Build in	3rd WiFi BG
AOA150-Ab	NLED8.9WSVGAG	CM512MB(1Gbx4)	SO512MBII6	N80GB5.4KS	5 in 1-Build in	3rd WiFi BG
AOA150-Ab	NLED8.9WSVGAG	CM512MB(1Gbx4)	SO512MBII6	N80GB5.4KS	5 in 1-Build in	3rd WiFi BG
AOA150-Ab	NLED8.9WSVGAG	CM512MB(1Gbx4)	SO512MBII6	N80GB5.4KS	5 in 1-Build in	3rd WiFi BG
AOA150-Ab	NLED8.9WSVGAG	CM512MB(1Gbx4)	SO512MBII6	N80GB5.4KS	5 in 1-Build in	3rd WiFi BG
AOA150-Ab	NLED8.9WSVGAG	CM512MB(1Gbx4)	SO512MBII6	N80GB5.4KS	5 in 1-Build in	3rd WiFi BG

Aspire one White

Model	RO	Country	Acer Part No	Description	CPU
AOA150-Bw	WW	WW	S2.S040B.001	AOA150-Bw AOXPHSTVW1 MC UMACw 2*512/80/6L/5R/CB_bg_0.3D_GE_EN11_C1 (TW)	ATMN270B
AOA150-Aw	EMEA	Eastern Europe	LU.S040A.051	AOA150-Aw AOLINXSEU4 UMACw 2*512/80/3L/5R/CB_bg_0.3D_BAG_GEW_EN81	ATMN270B
AOA150-Aw	EMEA	Germany	LU.S040A.048	AOA150-Aw AOLINXSEU1 UMACw 2*512/80/3L/5R/CB_bg_0.3D_BAG_GEW_IT31	ATMN270B
AOA150-Aw	EMEA	Sweden/Finland	LU.S040A.050	AOA150-Aw AOLINXSEU1 UMACw 2*512/80/3L/5R/CB_bg_0.3D_BAG_GEW_EN81	ATMN270B
AOA150-Aw	EMEA	Czech	LU.S040A.052	AOA150-Aw AOLINXSCZ2 UMACw 2*512/80/3L/5R/CB_bg_0.3D_BAG_GEW_EN21	ATMN270B
AOA150-Aw	EMEA	South Africa	LU.S040A.045	AOA150-Aw AOLINXSA1 UMACw 2*512/80/3L/5R/CB_bg_0.3D_BAG_GEW_FR51	ATMN270B
AOA150-Aw	EMEA	Luxembourg	LU.S040A.049	AOA150-Aw AOLINXSLU1 UMACw 2*512/80/3L/5R/CB_bg_0.3D_BAG_GEW_IT41	ATMN270B
AOA150-Aw	EMEA	South Africa	LU.S040A.044	AOA150-Aw AOLINXSA2 UMACw 2*512/80/3L/5R/CB_bg_0.3D_BAG_GEW_EN11	ATMN270B
AOA150-Aw	EMEA	France	LU.S040A.047	AOA150-Aw AOLINXSR1 UMACw 2*512/80/3L/5R/CB_bg_0.3D_BAG_GEW_IT31	ATMN270B
AOA150-Aw	EMEA	Denmark	LU.S040A.046	AOA150-Aw AOLINXSDK1 UMACw 2*512/80/3L/5R/CB_bg_0.3D_BAG_GEW_DA11	ATMN270B
AOA150-Aw	EMEA	Eastern Europe	LU.S040A.053	AOA150-Aw AOLINXSEU6 UMACw 2*512/80/3L/5R/CB_bg_0.3D_BAG_GEW_EN21	ATMN270B
AOA150-Aw	EMEA	Holland	LU.S040A.054	AOA150-Aw AOLINXSNL1 UMACw 2*512/80/3L/5R/CB_bg_0.3D_BAG_GEW_NL11	ATMN270B
AOA150-Aw	EMEA	Russia	LU.S040A.057	AOA150-Aw AOLINXSRU1 UMACw 2*512/80/3L/5R/CB_bg_0.3D_BAG_GEW_RU21	ATMN270B
AOA150-Aw	EMEA	Switzerland	LU.S040A.073	AOA150-Aw AOLINXSCH1 UMACw 2*512/80/3L/5R/CB_bg_0.3D_BAG_GEW_IT41	ATMN270B
AOA150-Aw	EMEA	Middle East	LU.S040A.072	AOA150-Aw AOLINXSME3 UMACw 2*512/80/3L/5R/CB_bg_0.3D_BAG_GEW_IT31	ATMN270B
AOA150-Aw	EMEA	Middle East	LU.S040A.071	AOA150-Aw AOLINXSME6 UMACw 2*512/80/3L/5R/CB_bg_0.3D_BAG_GEW_EN11	ATMN270B
AOA150-Aw	EMEA	Middle East	LU.S040A.070	AOA150-Aw AOLINXSME4 UMACw 2*512/80/3L/5R/CB_bg_0.3D_BAG_GEW_EN11	ATMN270B
AOA150-Aw	EMEA	Israel	LU.S040A.064	AOA150-Aw AOLINXSIL1 UMACw 2*512/80/3L/5R/CB_bg_0.3D_BAG_GEW_EN11	ATMN270B
AOA150-Aw	EMEA	Eastern Europe	LU.S040A.060	AOA150-Aw AOLINXSEU5 UMACw 2*512/80/3L/5R/CB_bg_0.3D_BAG_GEW_EN41	ATMN270B
AOA150-Aw	EMEA	Middle East	LU.S040A.069	AOA150-Aw AOLINXSME2 UMACw 2*512/80/3L/5R/CB_bg_0.3D_BAG_GEW_EN11	ATMN270B
AOA150-Aw	EMEA	Hungary	LU.S040A.059	AOA150-Aw AOLINXSHU1 UMACw 2*512/80/3L/5R/CB_bg_0.3D_BAG_GEW_EN41	ATMN270B
AOA150-Aw	EMEA	Eastern Europe	LU.S040A.058	AOA150-Aw AOLINXSEU3 UMACw 2*512/80/3L/5R/CB_bg_0.3D_BAG_GEW_RU21	ATMN270B
AOA150-Aw	EMEA	Middle East	LU.S040A.068	AOA150-Aw AOLINXSME9 UMACw 2*512/80/3L/5R/CB_bg_0.3D_BAG_GEW_IT31	ATMN270B
AOA150-Aw	EMEA	Spain	LU.S040A.063	AOA150-Aw AOLINXSES1 UMACw 2*512/80/3L/5R/CB_bg_0.3D_BAG_GEW_PT21	ATMN270B
AOA150-Aw	EMEA	Portugal	LU.S040A.062	AOA150-Aw AOLINXSPT1 UMACw 2*512/80/3L/5R/CB_bg_0.3D_BAG_GEW_PT21	ATMN270B
AOA150-Aw	EMEA	Greece	LU.S040A.067	AOA150-Aw AOLINXSGR1 UMACw 2*512/80/3L/5R/CB_bg_0.3D_BAG_GEW_EL41	ATMN270B
AOA150-Aw	EMEA	Norway	LU.S040A.056	AOA150-Aw AOLINXSNO1 UMACw 2*512/80/3L/5R/CB_bg_0.3D_BAG_GEW_DA11	ATMN270B
AOA150-Aw	EMEA	Italy	LU.S040A.066	AOA150-Aw AOLINXSIT1 UMACw 2*512/80/3L/5R/CB_bg_0.3D_BAG_GEW_IT31	ATMN270B
AOA150-Aw	EMEA	Belgium	LU.S040A.055	AOA150-Aw AOLINXSB1 UMACw 2*512/80/3L/5R/CB_bg_0.3D_BAG_GEW_NL11	ATMN270B
AOA150-Aw	EMEA	Turkey	LU.S040A.065	AOA150-Aw AOLINXSTR1 UMACw 2*512/80/3L/5R/CB_bg_0.3D_BAG_GEW_TR51	ATMN270B

Model	RO	Country	Acer Part No	Description	CPU
AOA150-Aw	EMEA	Slovenia/ Croatia	LU.S040A.061	AOA150-Aw AOLINXSSI1 UMACw 2*512/80/3L/5R/CB_bg_0.3D_BAG_GEW_EN11	ATMN270B
AOA150-Bw	EMEA	Luxembourg	LU.S040B.047	AOA150-Bw AOXPSTLU1 MC UMACw 1*512/80/3L/5R/CB_bg_0.3D_BAG_GEW_IT42	ATMN270B
AOA150-Aw	EMEA	UK	LU.S040A.105	AOA150-Aw AOLINXSGB1 UMACw 1*512/80/3L/5R/CB_bg_0.3D_BAG_GEW_EN11	ATMN270B
AOA150-Bw	EMEA	Denmark	LU.S040B.042	AOA150-Bw AOXPSTDK1 MC UMACw 1*512/80/3L/5R/CB_bg_0.3D_BAG_GEW_NO12	ATMN270B
AOA150-Bw	EMEA	South Africa	LU.S040B.041	AOA150-Bw AOXPSTZA2 MC UMACw 1*512/80/3L/5R/CB_bg_0.3D_BAG_GEW_EN12	ATMN270B
AOA150-Bw	EMEA	Germany	LU.S040B.044	AOA150-Bw AOXPSTDE1 MC UMACw 1*512/80/3L/5R/CB_bg_0.3D_BAG_GEW_DE12	ATMN270B
AOA150-Bw	EMEA	South Africa	LU.S040B.040	AOA150-Bw AOXPSTZA1 MC UMACw 1*512/80/3L/5R/CB_bg_0.3D_BAG_GEW_FR22	ATMN270B
AOA150-Bw	EMEA	Holland	LU.S040B.045	AOA150-Bw AOXPSTNL1 MC UMACw 1*512/80/3L/5R/CB_bg_0.3D_BAG_GEW_NL12	ATMN270B
AOA150-Aw	EMEA	Middle East	LU.S040A.102	AOA150-Aw AOLINXSME6 UMACw 1*512/80/3L/5R/CB_bg_0.3D_BAG_GEW_EN11	ATMN270B
AOA150-Aw	EMEA	Spain	LU.S040A.094	AOA150-Aw AOLINXSES1 UMACw 1*512/80/3L/5R/CB_bg_0.3D_BAG_GEW_PT21	ATMN270B
AOA150-Aw	EMEA	Middle East	LU.S040A.103	AOA150-Aw AOLINXSME3 UMACw 1*512/80/3L/5R/CB_bg_0.3D_BAG_GEW_IT31	ATMN270B
AOA150-Aw	EMEA	Middle East	LU.S040A.100	AOA150-Aw AOLINXSME2 UMACw 1*512/80/3L/5R/CB_bg_0.3D_BAG_GEW_EN11	ATMN270B
AOA150-Aw	EMEA	Greece	LU.S040A.098	AOA150-Aw AOLINXSGR1 UMACw 1*512/80/3L/5R/CB_bg_0.3D_BAG_GEW_EL41	ATMN270B
AOA150-Aw	EMEA	Middle East	LU.S040A.101	AOA150-Aw AOLINXSME4 UMACw 1*512/80/3L/5R/CB_bg_0.3D_BAG_GEW_EN11	ATMN270B
AOA150-Aw	EMEA	Switzerland	LU.S040A.104	AOA150-Aw AOLINXSCH1 UMACw 1*512/80/3L/5R/CB_bg_0.3D_BAG_GEW_IT41	ATMN270B
AOA150-Aw	EMEA	Italy	LU.S040A.097	AOA150-Aw AOLINXSIT1 UMACw 1*512/80/3L/5R/CB_bg_0.3D_BAG_GEW_IT31	ATMN270B
AOA150-Aw	EMEA	Israel	LU.S040A.095	AOA150-Aw AOLINXSIL1 UMACw 1*512/80/3L/5R/CB_bg_0.3D_BAG_GEW_EN11	ATMN270B
AOA150-Aw	EMEA	Middle East	LU.S040A.099	AOA150-Aw AOLINXSME9 UMACw 1*512/80/3L/5R/CB_bg_0.3D_BAG_GEW_IT31	ATMN270B
AOA150-Aw	EMEA	Turkey	LU.S040A.096	AOA150-Aw AOLINXSTR1 UMACw 1*512/80/3L/5R/CB_bg_0.3D_BAG_GEW_TR51	ATMN270B
AOA150-Bw	EMEA	France	LU.S040B.043	AOA150-Bw AOXPSTFR1 MC UMACw 1*512/80/3L/5R/CB_bg_0.3D_BAG_GEW_FR22	ATMN270B
AOA150-Bw	EMEA	Belgium	LU.S040B.046	AOA150-Bw AOXPSTBE1 MC UMACw 1*512/80/3L/5R/CB_bg_0.3D_BAG_GEW_NL12	ATMN270B
AOA150-Aw	EMEA	Russia	LU.S040A.088	AOA150-Aw AOLINXSRU1 UMACw 1*512/80/3L/5R/CB_bg_0.3D_BAG_GEW_RU21	ATMN270B
AOA150-Aw	EMEA	Slovenia/ Croatia	LU.S040A.092	AOA150-Aw AOLINXSSI1 UMACw 1*512/80/3L/5R/CB_bg_0.3D_BAG_GEW_EN11	ATMN270B
AOA150-Aw	EMEA	Belgium	LU.S040A.086	AOA150-Aw AOLINXSBE1 UMACw 1*512/80/3L/5R/CB_bg_0.3D_BAG_GEW_NL11	ATMN270B
AOA150-Aw	EMEA	Denmark	LU.S040A.077	AOA150-Aw AOLINXSDK1 UMACw 1*512/80/3L/5R/CB_bg_0.3D_BAG_GEW_DA11	ATMN270B
AOA150-Aw	EMEA	Norway	LU.S040A.087	AOA150-Aw AOLINXSN01 UMACw 1*512/80/3L/5R/CB_bg_0.3D_BAG_GEW_DA11	ATMN270B
AOA150-Aw	EMEA	South Africa	LU.S040A.076	AOA150-Aw AOLINXSZA1 UMACw 1*512/80/3L/5R/CB_bg_0.3D_BAG_GEW_FR51	ATMN270B
AOA150-Aw	EMEA	Portugal	LU.S040A.093	AOA150-Aw AOLINXSPT1 UMACw 1*512/80/3L/5R/CB_bg_0.3D_BAG_GEW_PT21	ATMN270B
AOA150-Aw	EMEA	Eastern Europe	LU.S040A.081	AOA150-Aw AOLINXSEU4 UMACw 1*512/80/3L/5R/CB_bg_0.3D_BAG_GEW_EN81	ATMN270B
AOA150-Aw	EMEA	Germany	LU.S040A.079	AOA150-Aw AOLINXSD1 UMACw 1*512/80/3L/5R/CB_bg_0.3D_BAG_GEW_IT31	ATMN270B
AOA150-Aw	EMEA	Sweden/ Finland	LU.S040A.080	AOA150-Aw AOLINXSSE1 UMACw 1*512/80/3L/5R/CB_bg_0.3D_BAG_GEW_EN81	ATMN270B

Model	RO	Country	Acer Part No	Description	CPU
AOA150-Aw	EMEA	Czech	LU.S040A.082	AOA150-Aw AOLINXSCZ2 UMACw 1*512/80/3L/5R/CB_bg_0.3D_BAG_GEW_EN21	ATMN270B
AOA150-Aw	EMEA	Eastern Europe	LU.S040A.083	AOA150-Aw AOLINXSEU6 UMACw 1*512/80/3L/5R/CB_bg_0.3D_BAG_GEW_EN21	ATMN270B
AOA150-Aw	EMEA	Eastern Europe	LU.S040A.089	AOA150-Aw AOLINXSEU3 UMACw 1*512/80/3L/5R/CB_bg_0.3D_BAG_GEW_RU21	ATMN270B
AOA150-Aw	EMEA	Hungary	LU.S040A.090	AOA150-Aw AOLINXSHU1 UMACw 1*512/80/3L/5R/CB_bg_0.3D_BAG_GEW_EN41	ATMN270B
AOA150-Aw	EMEA	Luxembourg	LU.S040A.084	AOA150-Aw AOLINXSLU1 UMACw 1*512/80/3L/5R/CB_bg_0.3D_BAG_GEW_IT41	ATMN270B
AOA150-Aw	EMEA	Eastern Europe	LU.S040A.091	AOA150-Aw AOLINXSEU5 UMACw 1*512/80/3L/5R/CB_bg_0.3D_BAG_GEW_EN41	ATMN270B
AOA150-Aw	EMEA	UK	LU.S040A.074	AOA150-Aw AOLINXSGB1 UMACw 2*512/80/3L/5R/CB_bg_0.3D_BAG_GEW_EN11	ATMN270B
AOA150-Aw	EMEA	South Africa	LU.S040A.075	AOA150-Aw AOLINXSAZ2 UMACw 1*512/80/3L/5R/CB_bg_0.3D_BAG_GEW_EN11	ATMN270B
AOA150-Aw	EMEA	France	LU.S040A.078	AOA150-Aw AOLINXFR1 UMACw 1*512/80/3L/5R/CB_bg_0.3D_BAG_GEW_IT31	ATMN270B
AOA150-Aw	EMEA	Holland	LU.S040A.085	AOA150-Aw AOLINXSNL1 UMACw 1*512/80/3L/5R/CB_bg_0.3D_BAG_GEW_NL11	ATMN270B
AOA150-Bw	EMEA	France	LU.S040B.077	AOA150-Bw AOXPSTFR1 MC UMACw 2*512/80/3L/5R/CB_bg_0.3D_BAG_GEW_FR22	ATMN270B
AOA150-Bw	EMEA	Belgium	LU.S040B.080	AOA150-Bw AOXPSTBE1 MC UMACw 2*512/80/3L/5R/CB_bg_0.3D_BAG_GEW_NL12	ATMN270B
AOA150-Bw	EMEA	Middle East	LU.S040B.068	AOA150-Bw AOXPSTME2 MC UMACw 1*512/80/3L/5R/CB_bg_0.3D_BAG_GEW_EN12	ATMN270B
AOA150-Bw	EMEA	Luxembourg	LU.S040B.081	AOA150-Bw AOXPSTLU1 MC UMACw 2*512/80/3L/5R/CB_bg_0.3D_BAG_GEW_IT42	ATMN270B
AOA150-Bw	EMEA	Holland	LU.S040B.079	AOA150-Bw AOXPSTNL1 MC UMACw 2*512/80/3L/5R/CB_bg_0.3D_BAG_GEW_NL12	ATMN270B
AOA150-Bw	EMEA	Sweden/ Finland	LU.S040B.084	AOA150-Bw AOXPSTSE1 MC UMACw 2*512/80/3L/5R/CB_bg_0.3D_BAG_GEW_FI12	ATMN270B
AOA150-Bw	EMEA	Eastern Europe	LU.S040B.085	AOA150-Bw AOXPSTEU5 MC UMACw 2*512/80/3L/5R/CB_bg_0.3D_BAG_GEW_PL12	ATMN270B
AOA150-Bw	EMEA	South Africa	LU.S040B.074	AOA150-Bw AOXPSTZA1 MC UMACw 2*512/80/3L/5R/CB_bg_0.3D_BAG_GEW_FR22	ATMN270B
AOA150-Bw	EMEA	Eastern Europe	LU.S040B.086	AOA150-Bw AOXPSTEU4 MC UMACw 2*512/80/3L/5R/CB_bg_0.3D_BAG_GEW_FI12	ATMN270B
AOA150-Bw	EMEA	Norway	LU.S040B.082	AOA150-Bw AOXPSTNO1 MC UMACw 2*512/80/3L/5R/CB_bg_0.3D_BAG_GEW_NO12	ATMN270B
AOA150-Bw	EMEA	Germany	LU.S040B.078	AOA150-Bw AOXPSTDE1 MC UMACw 2*512/80/3L/5R/CB_bg_0.3D_BAG_GEW_DE12	ATMN270B
AOA150-Bw	EMEA	Eastern Europe	LU.S040B.087	AOA150-Bw AOXPSTEU6 MC UMACw 2*512/80/3L/5R/CB_bg_0.3D_BAG_GEW_CS22	ATMN270B
AOA150-Bw	EMEA	Middle East	LU.S040B.071	AOA150-Bw AOXPSTME2 MC UMACw 1*512/80/3L/5R/CB_bg_0.3D_BAG_GEW_AR12	ATMN270B
AOA150-Bw	EMEA	South Africa	LU.S040B.075	AOA150-Bw AOXPSTZA2 MC UMACw 2*512/80/3L/5R/CB_bg_0.3D_BAG_GEW_EN12	ATMN270B
AOA150-Bw	EMEA	Denmark	LU.S040B.076	AOA150-Bw AOXPSTDK1 MC UMACw 2*512/80/3L/5R/CB_bg_0.3D_BAG_GEW_NO12	ATMN270B
AOA150-Bw	EMEA	Russia	LU.S040B.083	AOA150-Bw AOXPSTRU1 MC UMACw 2*512/80/3L/5R/CB_bg_0.3D_BAG_GEW_RU12	ATMN270B
AOA150-Bw	EMEA	Middle East	LU.S040B.069	AOA150-Bw AOXPSTME6 MC UMACw 1*512/80/3L/5R/CB_bg_0.3D_BAG_GEW_EN12	ATMN270B
AOA150-Bw	EMEA	Middle East	LU.S040B.070	AOA150-Bw AOXPSTME4 MC UMACw 1*512/80/3L/5R/CB_bg_0.3D_BAG_GEW_EN12	ATMN270B
AOA150-Bw	EMEA	Switzerland	LU.S040B.072	AOA150-Bw AOXPSTCH1 MC UMACw 1*512/80/3L/5R/CB_bg_0.3D_BAG_GEW_IT42	ATMN270B
AOA150-Bw	EMEA	UK	LU.S040B.073	AOA150-Bw AOXPSTGB1 MC UMACw 1*512/80/3L/5R/CB_bg_0.3D_BAG_GEW_EN12	ATMN270B
AOA150-Bw	EMEA	Czech	LU.S040B.090	AOA150-Bw AOXPSTCZ2 MC UMACw 2*512/80/3L/5R/CB_bg_0.3D_BAG_GEW_SK12	ATMN270B

Model	RO	Country	Acer Part No	Description	CPU
AOA150-Bw	EMEA	Eastern Europe	LU.S040B.089	AOA150-Bw AOXPSTEU3 MC UMACw 2*512/80/3L/5R/CB_bg_0.3D_BAG_GEW_RU12	ATMN270B
AOA150-Bw	EMEA	Turkey	LU.S040B.096	AOA150-Bw AOXPSTTR1 MC UMACw 2*512/80/3L/5R/CB_bg_0.3D_BAG_GEW_TR32	ATMN270B
AOA150-Bw	EMEA	Middle East	LU.S040B.102	AOA150-Bw AOXPSTME2 MC UMACw 2*512/80/3L/5R/CB_bg_0.3D_BAG_GEW_EN12	ATMN270B
AOA150-Bw	EMEA	Middle East	LU.S040B.101	AOA150-Bw AOXPSTME9 MC UMACw 2*512/80/3L/5R/CB_bg_0.3D_BAG_GEW_FR22	ATMN270B
AOA150-Bw	EMEA	Switzerland	LU.S040B.106	AOA150-Bw AOXPSTCH1 MC UMACw 2*512/80/3L/5R/CB_bg_0.3D_BAG_GEW_IT42	ATMN270B
AOA150-Bw	EMEA	Middle East	LU.S040B.099	AOA150-Bw AOXPSTME2 MC UMACw 2*512/80/3L/5R/CB_bg_0.3D_BAG_GEW_AR22	ATMN270B
AOA150-Bw	EMEA	Middle East	LU.S040B.100	AOA150-Bw AOXPSTME3 MC UMACw 2*512/80/3L/5R/CB_bg_0.3D_BAG_GEW_FR22	ATMN270B
AOA150-Bw	EMEA	Slovenia/Croatia	LU.S040B.092	AOA150-Bw AOXPSTSI1 MC UMACw 2*512/80/3L/5R/CB_bg_0.3D_BAG_GEW_EN12	ATMN270B
AOA150-Bw	EMEA	Spain	LU.S040B.094	AOA150-Bw AOXPSTES1 MC UMACw 2*512/80/3L/5R/CB_bg_0.3D_BAG_GEW_ES22	ATMN270B
AOA150-Bw	EMEA	Israel	LU.S040B.095	AOA150-Bw AOXPSTIL1 MC UMACw 2*512/80/3L/5R/CB_bg_0.3D_BAG_GEW_HE12	ATMN270B
AOA150-Bw	EMEA	Greece	LU.S040B.097	AOA150-Bw AOXPSTGR1 MC UMACw 2*512/80/3L/5R/CB_bg_0.3D_BAG_GEW_EL32	ATMN270B
AOA150-Bw	EMEA	Middle East	LU.S040B.103	AOA150-Bw AOXPSTME6 MC UMACw 2*512/80/3L/5R/CB_bg_0.3D_BAG_GEW_EN12	ATMN270B
AOA150-Bw	EMEA	Eastern Europe	LU.S040B.088	AOA150-Bw AOXPSTEU3 MC UMACw 2*512/80/3L/5R/CB_bg_0.3D_BAG_GEW_RU22	ATMN270B
AOA150-Bw	EMEA	Middle East	LU.S040B.104	AOA150-Bw AOXPSTME4 MC UMACw 2*512/80/3L/5R/CB_bg_0.3D_BAG_GEW_EN12	ATMN270B
AOA150-Bw	EMEA	Hungary	LU.S040B.091	AOA150-Bw AOXPSTHU1 MC UMACw 2*512/80/3L/5R/CB_bg_0.3D_BAG_GEW_HU12	ATMN270B
AOA150-Bw	EMEA	UK	LU.S040B.107	AOA150-Bw AOXPSTGB1 MC UMACw 2*512/80/3L/5R/CB_bg_0.3D_BAG_GEW_EN12	ATMN270B
AOA150-Bw	EMEA	Italy	LU.S040B.098	AOA150-Bw AOXPSTIT1 MC UMACw 2*512/80/3L/5R/CB_bg_0.3D_BAG_GEW_IT12	ATMN270B
AOA150-Bw	EMEA	Middle East	LU.S040B.105	AOA150-Bw AOXPSTME2 MC UMACw 2*512/80/3L/5R/CB_bg_0.3D_BAG_GEW_AR12	ATMN270B
AOA150-Bw	EMEA	Portugal	LU.S040B.093	AOA150-Bw AOXPSTPT1 MC UMACw 2*512/80/3L/5R/CB_bg_0.3D_BAG_GEW_PT12	ATMN270B
AOA150-Bw	EMEA	Middle East	LU.S040B.065	AOA150-Bw AOXPSTME2 MC UMACw 1*512/80/3L/5R/CB_bg_0.3D_BAG_GEW_AR22	ATMN270B
AOA150-Bw	EMEA	Portugal	LU.S040B.059	AOA150-Bw AOXPSTPT1 MC UMACw 1*512/80/3L/5R/CB_bg_0.3D_BAG_GEW_PT12	ATMN270B
AOA150-Bw	EMEA	Middle East	LU.S040B.066	AOA150-Bw AOXPSTME3 MC UMACw 1*512/80/3L/5R/CB_bg_0.3D_BAG_GEW_FR22	ATMN270B
AOA150-Bw	EMEA	Middle East	LU.S040B.067	AOA150-Bw AOXPSTME9 MC UMACw 1*512/80/3L/5R/CB_bg_0.3D_BAG_GEW_FR22	ATMN270B
AOA150-Bw	EMEA	Sweden/Finland	LU.S040B.048	AOA150-Bw AOXPSTSE1 MC UMACw 1*512/80/3L/5R/CB_bg_0.3D_BAG_GEW_FI12	ATMN270B
AOA150-Bw	EMEA	Eastern Europe	LU.S040B.049	AOA150-Bw AOXPSTEU5 MC UMACw 1*512/80/3L/5R/CB_bg_0.3D_BAG_GEW_PL12	ATMN270B
AOA150-Bw	EMEA	Eastern Europe	LU.S040B.050	AOA150-Bw AOXPSTEU4 MC UMACw 1*512/80/3L/5R/CB_bg_0.3D_BAG_GEW_FI12	ATMN270B
AOA150-Bw	EMEA	Norway	LU.S040B.055	AOA150-Bw AOXPSTNO1 MC UMACw 1*512/80/3L/5R/CB_bg_0.3D_BAG_GEW_NO12	ATMN270B
AOA150-Bw	EMEA	Slovenia/Croatia	LU.S040B.058	AOA150-Bw AOXPSTSI1 MC UMACw 1*512/80/3L/5R/CB_bg_0.3D_BAG_GEW_EN12	ATMN270B
AOA150-Bw	EMEA	Spain	LU.S040B.060	AOA150-Bw AOXPSTES1 MC UMACw 1*512/80/3L/5R/CB_bg_0.3D_BAG_GEW_ES22	ATMN270B
AOA150-Bw	EMEA	Eastern Europe	LU.S040B.051	AOA150-Bw AOXPSTEU6 MC UMACw 1*512/80/3L/5R/CB_bg_0.3D_BAG_GEW_CS22	ATMN270B
AOA150-Bw	EMEA	Israel	LU.S040B.061	AOA150-Bw AOXPSTIL1 MC UMACw 1*512/80/3L/5R/CB_bg_0.3D_BAG_GEW_HE12	ATMN270B

Model	RO	Country	Acer Part No	Description	CPU
AOA150-Bw	EMEA	Turkey	LU.S040B.062	AOA150-Bw AOXPSTTR1 MC UMACw 1*512/80/3L/5R/CB_bg_0.3D_BAG_GEW_TR32	ATMN270B
AOA150-Bw	EMEA	Russia	LU.S040B.056	AOA150-Bw AOXPSTRU1 MC UMACw 1*512/80/3L/5R/CB_bg_0.3D_BAG_GEW_RU12	ATMN270B
AOA150-Bw	EMEA	Greece	LU.S040B.063	AOA150-Bw AOXPSTGR1 MC UMACw 1*512/80/3L/5R/CB_bg_0.3D_BAG_GEW_EL32	ATMN270B
AOA150-Bw	EMEA	Eastern Europe	LU.S040B.052	AOA150-Bw AOXPSTEU3 MC UMACw 1*512/80/3L/5R/CB_bg_0.3D_BAG_GEW_RU22	ATMN270B
AOA150-Bw	EMEA	Eastern Europe	LU.S040B.053	AOA150-Bw AOXPSTEU3 MC UMACw 1*512/80/3L/5R/CB_bg_0.3D_BAG_GEW_RU12	ATMN270B
AOA150-Bw	EMEA	Czech	LU.S040B.054	AOA150-Bw AOXPSTCZ2 MC UMACw 1*512/80/3L/5R/CB_bg_0.3D_BAG_GEW_SK12	ATMN270B
AOA150-Bw	EMEA	Hungary	LU.S040B.057	AOA150-Bw AOXPSTHU1 MC UMACw 1*512/80/3L/5R/CB_bg_0.3D_BAG_GEW_HU12	ATMN270B
AOA150-Bw	EMEA	Italy	LU.S040B.064	AOA150-Bw AOXPSTIT1 MC UMACw 1*512/80/3L/5R/CB_bg_0.3D_BAG_GEW_IT12	ATMN270B
AOA150-Bw	WW	WW	S2.S040B.002	AOA150-Bw AOXPSTWW1 MC UMACw 2*512/80/6L/5R/CB_bg_0.3D_BAG_GEW_EN11	ATMN270B
AOA150-Aw	AAP	Singapore	LU.S040A.012	AOA150-Aw AOLINXSSG1 UMACw 1*512/120/6L/5R/CB_bg_N_BAG_GEW_EN11	ATMN270B
AOA150-Aw	AAP	Australia/ New Zealand	LU.S040A.011	AOA150-Aw AOLINXSAU1 UMACw 1*512/120/3L/5R/CB_bg_N_BAG_GEW_EN11	ATMN270B
AOA150-Aw	AAP	Malaysia	LU.S040A.020	AOA150-Aw AOLINXSMY1 UMACw 1*512/120/6L/5R/CB_bg_N_BAG_GEW_EN11	ATMN270B
AOA150-Aw	AAP	Indonesia	LU.S040A.016	AOA150-Aw AOLINXSID1 UMACw 1*512/120/6L/5R/CB_bg_N_BAG_GEW_ID21	ATMN270B
AOA150-Aw	AAP	India	LU.S040A.014	AOA150-Aw AOLINXSIN1 UMACw 1*512/120/6L/5R/CB_bg_N_BAG_GEW_EN11	ATMN270B
AOA150-Aw	AAP	Singapore	LU.S040A.013	AOA150-Aw AOLINXSSG1 UMACw 1*512/120/6L/5R/CB_bg_N_BAG_GEW_ZH31	ATMN270B
AOA150-Aw	AAP	Vietnam	LU.S040A.018	AOA150-Aw AOLINXSVN1 UMACw 1*512/120/6L/5R/CB_bg_N_BAG_GEW_EN11	ATMN270B
AOA150-Aw	AAP	Philippines	LU.S040A.019	AOA150-Aw AOLINXSPH1 UMACw 1*512/120/6L/5R/CB_bg_N_BAG_GEW_EN11	ATMN270B
AOA150-Aw	AAP	Japan	LU.S040A.017	AOA150-Aw AOLINXSJP1 UMACw 1*512/120/6L/5R/CB_bg_N_BAG_GEW_JA11	ATMN270B
AOA150-Aw	AAP	Indonesia	LU.S040A.015	AOA150-Aw AOLINXSID1 UMACw 1*512/120/6L/5R/CB_bg_N_BAG_GEW_EN11	ATMN270B
AOA150-Bw	AAP	Japan	LU.S040B.117	AOA150-Bw AOXPJSJP1 MC UMACw 2*512/120/3L/5R/CB_bg_0.3D_BAG_GEW_JA11	ATMN270B
AOA150-Bw	AAP	Indonesia	LU.S040B.037	AOA150-Bw AOXPSTID1 MC UMACw 1*512/120/6L/5R/CB_bg_N_BAG_GEW_EN11	ATMN270B
AOA150-Bw	AAP	Indonesia	LU.S040B.038	AOA150-Bw AOXPSTID1 MC UMACw 1*512/120/6L/5R/CB_bg_N_BAG_GEW_ID21	ATMN270B
AOA150-Bw	AAP	India	LU.S040B.036	AOA150-Bw AOXPSTIN1 MC UMACw 1*512/120/6L/5R/CB_bg_N_BAG_GEW_EN11	ATMN270B
AOA150-Bw	TWN	GCTWN	LU.S040B.039	AOA150-Bw AOXPSTTW1 MC UMACw 2*512/120/6L/5R/CB_bg_0.3D_BAG_GEW_TC11	ATMN270B
AOA150-Bw	TWN	GCTWN	LU.S040B.008	AOA150-Bw AOXPSTTW1 MC UMACw 512+1G/120/6L/5R/CB_bg_0.3D_BAG_GEW_TC11	ATMN270B
AOA150-Aw	TWN	GCTWN	LU.S040A.001	AOA150-Aw AOLINXSTW1 UMACw 512+1G/120/6L/5R/CB_bg_0.3D_BAG_GEW_TC11	ATMN270B
AOA150-Bw	TWN	GCTWN	LU.S040B.108	AOA150-Bw AOXPSTTW1 MC UMACw 2*512/120/3L/5R/CB_bg_0.3D_BAG_GEW_TC11	ATMN270B
AOA150-Aw	TWN	GCTWN	LU.S040A.002	AOA150-Aw AOLINXSTW1 UMACw 512+1G/120/6L/5R/CB_bg_0.3D_BAG_GEW_TC21	ATMN270B
AOA150-Aw	CHINA	Hong Kong	LU.S040A.005	AOA150-Aw AOLINXSHK2 UMACw 512+1G/120/6L/5R/CB_bg_0.3D_BAG_GEW_EN91	ATMN270B
AOA150-Aw	CHINA	Hong Kong	LU.S040A.004	AOA150-Aw AOLINXSHK2 UMACw 512+1G/120/6L/5R/CB_bg_0.3D_BAG_GEW_ZH31	ATMN270B

Model	RO	Country	Acer Part No	Description	CPU
AOA150-Bw	CHINA	China	LU.S040B.006	AOA150-Bw AOXPSTCN1 MC UMACw 512+1G/120/6L/5R/ CB_bg_0.3D_BAG_GEW_SC11	ATMN270B
AOA150-Aw	CHINA	China	LU.S040A.003	AOA150-Aw AOLINXSCN1 UMACw 512+1G/120/ 6L/5R/CB_bg_0.3D_BAG_GEW_SC12	ATMN270B
AOA150-Bw	CHINA	Hong Kong	LU.S040B.007	AOA150-Bw AOXPSTHK2 MC UMACw 512+1G/120/6L/5R/ CB_bg_0.3D_BAG_GEW_ZH31	ATMN270B
AOA150-Aw	AAP	Thailand	LU.S040A.021	AOA150-Aw AOLINXSTH1 UMACw 1*512/120/ 6L/5R/CB_bg_N_BAG_GEW_TH21	ATMN270B
AOA150-Aw	AAP	Philippines	LU.S040A.029	AOA150-Aw AOLINXSPH1 UMACw 2*512/120/ 6L/5R/CB_bg_N_BAG_GEW_EN11	ATMN270B
AOA150-Aw	AAP	Japan	LU.S040A.028	AOA150-Aw AOLINXSJP1 UMACw 2*512/120/ 6L/5R/CB_bg_N_BAG_GEW_JA11	ATMN270B
AOA150-Aw	AAP	Australia/ New Zealand	LU.S040A.022	AOA150-Aw AOLINXSAU1 UMACw 2*512/120/ 3L/5R/CB_bg_N_BAG_GEW_EN11	ATMN270B
AOA150-Aw	AAP	India	LU.S040A.025	AOA150-Aw AOLINXSIN1 UMACw 2*512/120/6L/ 5R/CB_bg_N_BAG_GEW_EN11	ATMN270B
AOA150-Aw	AAP	Singapore	LU.S040A.023	AOA150-Aw AOLINXSSG1 UMACw 2*512/120/ 6L/5R/CB_bg_N_BAG_GEW_EN11	ATMN270B
AOA150-Aw	AAP	Malaysia	LU.S040A.030	AOA150-Aw AOLINXSMY1 UMACw 2*512/120/ 6L/5R/CB_bg_N_BAG_GEW_EN11	ATMN270B
AOA150-Aw	AAP	Indonesia	LU.S040A.027	AOA150-Aw AOLINXSID1 UMACw 2*512/120/6L/ 5R/CB_bg_N_BAG_GEW_ID21	ATMN270B
AOA150-Aw	AAP	Singapore	LU.S040A.024	AOA150-Aw AOLINXSSG1 UMACw 2*512/120/ 6L/5R/CB_bg_N_BAG_GEW_ZH31	ATMN270B
AOA150-Aw	AAP	Indonesia	LU.S040A.026	AOA150-Aw AOLINXSID1 UMACw 2*512/120/6L/ 5R/CB_bg_N_BAG_GEW_EN11	ATMN270B
AOA150-Aw	AAP	Singapore	LU.S040A.036	AOA150-Aw AOLINXSSG1 UMACw 512+1G/120/ 6L/5R/CB_bg_N_BAG_GEW_ZH31	ATMN270B
AOA150-Aw	AAP	Singapore	LU.S040A.034	AOA150-Aw AOLINXSSG1 UMACw 512+1G/120/ 6L/5R/CB_bg_N_BAG_GEW_EN11	ATMN270B
AOA150-Aw	AAP	Vietnam	LU.S040A.031	AOA150-Aw AOLINXSVN1 UMACw 2*512/120/ 6L/5R/CB_bg_N_BAG_GEW_EN11	ATMN270B
AOA150-Aw	AAP	Vietnam	LU.S040A.035	AOA150-Aw AOLINXSVN1 UMACw 512+1G/120/ 6L/5R/CB_bg_N_BAG_GEW_EN11	ATMN270B
AOA150-Aw	AAP	Indonesia	LU.S040A.038	AOA150-Aw AOLINXSID1 UMACw 512+1G/120/ 6L/5R/CB_bg_N_BAG_GEW_EN11	ATMN270B
AOA150-Aw	AAP	India	LU.S040A.037	AOA150-Aw AOLINXSIN1 UMACw 512+1G/120/ 6L/5R/CB_bg_N_BAG_GEW_EN11	ATMN270B
AOA150-Aw	AAP	Indonesia	LU.S040A.039	AOA150-Aw AOLINXSID1 UMACw 512+1G/120/ 6L/5R/CB_bg_N_BAG_GEW_ID21	ATMN270B
AOA150-Aw	AAP	Japan	LU.S040A.040	AOA150-Aw AOLINXSJP1 UMACw 512+1G/120/ 6L/5R/CB_bg_N_BAG_GEW_JA11	ATMN270B
AOA150-Aw	AAP	Australia/ New Zealand	LU.S040A.033	AOA150-Aw AOLINXSAU1 UMACw 512+1G/120/ 6L/5R/CB_bg_N_BAG_GEW_EN11	ATMN270B
AOA150-Aw	AAP	Thailand	LU.S040A.032	AOA150-Aw AOLINXSTH1 UMACw 2*512/120/ 6L/5R/CB_bg_N_BAG_GEW_TH21	ATMN270B
AOA150-Bw	AAP	Japan	LU.S040B.010	AOA150-Bw AOXPJSJP1 MC UMACw 2*512/ 120/6L/5R/CB_bg_N_BAG_GEW_JA11	ATMN270B
AOA150-Aw	AAP	Philippines	LU.S040A.041	AOA150-Aw AOLINXSPH1 UMACw 512+1G/120/ 6L/5R/CB_bg_N_BAG_GEW_EN11	ATMN270B
AOA150-Aw	AAP	Thailand	LU.S040A.043	AOA150-Aw AOLINXSTH1 UMACw 512+1G/120/ 6L/5R/CB_bg_N_BAG_GEW_TH21	ATMN270B
AOA150-Aw	AAP	Malaysia	LU.S040A.042	AOA150-Aw AOLINXSMY1 UMACw 512+1G/120/ 6L/5R/CB_bg_N_BAG_GEW_EN11	ATMN270B
AOA150-Bw	AAP	Vietnam	LU.S040B.014	AOA150-Bw AOXPSTVN1 MC UMACw 2*512/ 120/6L/5R/CB_bg_N_BAG_GEW_EN11	ATMN270B
AOA150-Bw	AAP	Philippines	LU.S040B.011	AOA150-Bw AOXPSTPH1 MC UMACw 2*512/ 120/6L/5R/CB_bg_N_BAG_GEW_EN11	ATMN270B

Model	RO	Country	Acer Part No	Description	CPU
AOA150-Bw	AAP	Singapore	LU.S040B.009	AOA150-Bw AOXPSTSG1 MC UMACw 2*512/120/6L/5R/CB_bg_N_BAG_GEW_EN11	ATMN270B
AOA150-Bw	AAP	Singapore	LU.S040B.015	AOA150-Bw AOXPSTSG1 MC UMACw 512+1G/120/6L/5R/CB_bg_N_BAG_GEW_EN11	ATMN270B
AOA150-Bw	AAP	Malaysia	LU.S040B.012	AOA150-Bw AOXPSTMY1 MC UMACw 2*512/120/6L/5R/CB_bg_N_BAG_GEW_EN11	ATMN270B
AOA150-Bw	AAP	Thailand	LU.S040B.013	AOA150-Bw AOXPSTTH1 MC UMACw 2*512/120/3L/5R/CB_bg_N_BAG_GEW_TH21	ATMN270B
AOA150-Bw	AAP	Thailand	LU.S040B.019	AOA150-Bw AOXPSTTH1 MC UMACw 512+1G/120/6L/5R/CB_bg_N_BAG_GEW_TH21	ATMN270B
AOA150-Bw	AAP	Malaysia	LU.S040B.018	AOA150-Bw AOXPSTMY1 MC UMACw 512+1G/120/6L/5R/CB_bg_N_BAG_GEW_EN11	ATMN270B
AOA150-Bw	AAP	Thailand	LU.S040B.025	AOA150-Bw AOXPSTTH1 MC UMACw 1*512/120/6L/5R/CB_bg_N_BAG_GEW_TH21	ATMN270B
AOA150-Bw	AAP	Philippines	LU.S040B.023	AOA150-Bw AOXPSTPH1 MC UMACw 1*512/120/6L/5R/CB_bg_N_BAG_GEW_EN11	ATMN270B
AOA150-Bw	AAP	Japan	LU.S040B.016	AOA150-Bw AOXPSTJP1 MC UMACw 512+1G/120/6L/5R/CB_bg_N_BAG_GEW_JA11	ATMN270B
AOA150-Bw	AAP	Japan	LU.S040B.022	AOA150-Bw AOXPSTJP1 MC UMACw 1*512/120/6L/5R/CB_bg_N_BAG_GEW_JA11	ATMN270B
AOA150-Bw	AAP	Philippines	LU.S040B.017	AOA150-Bw AOXPSTPH1 MC UMACw 512+1G/120/6L/5R/CB_bg_N_BAG_GEW_EN11	ATMN270B
AOA150-Bw	AAP	Vietnam	LU.S040B.020	AOA150-Bw AOXPSTVN1 MC UMACw 512+1G/120/6L/5R/CB_bg_N_BAG_GEW_EN11	ATMN270B
AOA150-Bw	AAP	Singapore	LU.S040B.021	AOA150-Bw AOXPSTSG1 MC UMACw 1*512/120/6L/5R/CB_bg_N_BAG_GEW_EN11	ATMN270B
AOA150-Bw	AAP	Malaysia	LU.S040B.024	AOA150-Bw AOXPSTMY1 MC UMACw 1*512/120/6L/5R/CB_bg_N_BAG_GEW_EN11	ATMN270B
AOA150-Bw	AAP	Indonesia	LU.S040B.034	AOA150-Bw AOXPSTID1 MC UMACw 512+1G/120/6L/5R/CB_bg_N_BAG_GEW_ID21	ATMN270B
AOA150-Bw	AAP	India	LU.S040B.032	AOA150-Bw AOXPSTIN1 MC UMACw 512+1G/120/6L/5R/CB_bg_N_BAG_GEW_EN11	ATMN270B
AOA150-Bw	AAP	India	LU.S040B.028	AOA150-Bw AOXPSTIN1 MC UMACw 2*512/120/6L/5R/CB_bg_N_BAG_GEW_EN11	ATMN270B
AOA150-Bw	AAP	Australia/ New Zealand	LU.S040B.031	AOA150-Bw AOXPSTAU1 MC UMACw 512+1G/120/3L/5R/CB_bg_N_BAG_GEW_EN11	ATMN270B
AOA150-Bw	AAP	Indonesia	LU.S040B.029	AOA150-Bw AOXPSTID1 MC UMACw 2*512/120/6L/5R/CB_bg_N_BAG_GEW_EN11	ATMN270B
AOA150-Bw	AAP	Australia/ New Zealand	LU.S040B.035	AOA150-Bw AOXPSTAU1 MC UMACw 1*512/120/3L/5R/CB_bg_N_BAG_GEW_EN11	ATMN270B
AOA150-Bw	AAP	Indonesia	LU.S040B.033	AOA150-Bw AOXPSTID1 MC UMACw 512+1G/120/6L/5R/CB_bg_N_BAG_GEW_EN11	ATMN270B
AOA150-Bw	AAP	Indonesia	LU.S040B.030	AOA150-Bw AOXPSTID1 MC UMACw 2*512/120/6L/5R/CB_bg_N_BAG_GEW_ID21	ATMN270B
AOA150-Bw	AAP	Vietnam	LU.S040B.026	AOA150-Bw AOXPSTVN1 MC UMACw 1*512/120/6L/5R/CB_bg_N_BAG_GEW_EN11	ATMN270B
AOA150-Bw	AAP	Australia/ New Zealand	LU.S040B.027	AOA150-Bw AOXPSTAU1 MC UMACw 2*512/120/3L/5R/CB_bg_N_BAG_GEW_EN11	ATMN270B
AOA150-Bw	AAP	Malaysia	LU.S040B.118	AOA150-Bw AOXPSTMY1 MC UMACw 2*512/120/3L/5R/CB_bg_0.3D_BAG_GEW_EN11	ATMN270B
AOA150-Aw	AAP	Vietnam	LU.S040A.114	AOA150-Aw AOLINXSVN1 UMACw 512+1G/120/3L/5R/CB_bg_0.3D_BAG_GEW_EN11	ATMN270B
AOA150-Aw	AAP	Vietnam	LU.S040A.113	AOA150-Aw AOLINXSVN1 UMACw 512+1G/120/6L/5R/CB_bg_0.3D_BAG_GEW_EN11	ATMN270B
AOA150-Bw	PA	ACLA-Spanish	LU.S040B.115	AOA150-Bw AOXPSTEA1 MC UMACw 2*512/120/3L/5R/CB_bg_0.3D_BAG_GEW_ES21	ATMN270B
AOA150-Bw	PA	ACLA-Spanish	LU.S040B.112	AOA150-Bw AOXPSTEA3 MC UMACw 512+1G/120/3L/5R/CB_bg_0.3D_BAG_GEW_ES21	ATMN270B

Model	RO	Country	Acer Part No	Description	CPU
AOA150-Bw	PA	ACLA-Spanish	LU.S040B.114	AOA150-Bw AOXPHESTEA3 MC UMACw 2*512/120/3L/5R/CB_bg_0.3D_BAG_GEW_ES21	ATMN270B
AOA150-Aw	PA	ACLA-Spanish	LU.S040A.110	AOA150-Aw AOLINXSEA3 UMACw 2*512/120/3L/5R/CB_bg_0.3D_BAG_GEW_ES21	ATMN270B
AOA150-Aw	PA	ACLA-Spanish	LU.S040A.010	AOA150-Aw AOLINXSEA3 UMACw 512+1G/120/6L/5R/CB_bg_0.3D_BAG_GEW_ES21	ATMN270B
AOA150-Aw	PA	USA	LU.S040A.007	AOA150-Aw AOLINXSUS1 UMACw 512+1G/120/6L/5R/CB_bg_0.3D_BAG_GEW_EN31	ATMN270B
AOA150-Aw	PA	USA	LU.S040A.109	AOA150-Aw AOLINXSUS1 UMACw 2*512/120/3L/5R/CB_bg_0.3D_BAG_GEW_EN31	ATMN270B
AOA150-Aw	PA	USA	LU.S040A.108	AOA150-Aw AOLINXSUS1 UMACw 1*512/120/3L/5R/CB_bg_0.3D_BAG_GEW_EN31	ATMN270B
AOA150-Aw	PA	Canada	LU.S040A.006	AOA150-Aw AOLINXSCA2 UMACw 512+1G/120/6L/5R/CB_bg_0.3D_BAG_GEW_FR31	ATMN270B
AOA150-Aw	PA	Canada	LU.S040A.107	AOA150-Aw AOLINXSCA2 UMACw 1*512/120/3L/5R/CB_bg_0.3D_BAG_GEW_FR31	ATMN270B
AOA150-Aw	PA	ACLA-Spanish	LU.S040A.009	AOA150-Aw AOLINXSEA1 UMACw 512+1G/120/6L/5R/CB_bg_0.3D_BAG_GEW_ES21	ATMN270B
AOA150-Aw	PA	ACLA-Portuguese	LU.S040A.008	AOA150-Aw AOLINXSXC1 UMACw 512+1G/120/6L/5R/CB_bg_0.3D_BAG_GEW_XC21	ATMN270B
AOA150-Aw	PA	Canada	LU.S040A.106	AOA150-Aw AOLINXSCA2 UMACw 2*512/120/3L/5R/CB_bg_0.3D_BAG_GEW_FR31	ATMN270B
AOA150-Aw	PA	ACLA-Portuguese	LU.S040A.112	AOA150-Aw AOLINXSXC1 UMACw 2*512/120/3L/5R/CB_bg_0.3D_BAG_GEW_XC21	ATMN270B
AOA150-Bw	PA	USA	LU.S040B.001	AOA150-Bw AOXPHESTUS1 MC UMACw 2*512/120/6L/5R/CB_bg_0.3D_BAG_GEW_EN31	ATMN270B
AOA150-Bw	PA	ACLA-Spanish	LU.S040B.111	AOA150-Bw AOXPHESTEA1 MC UMACw 512+1G/120/3L/5R/CB_bg_0.3D_BAG_GEW_ES21	ATMN270B
AOA150-Bw	PA	ACLA-Spanish	LU.S040B.005	AOA150-Bw AOXPHESTEA3 MC UMACw 2*512/120/6L/5R/CB_bg_0.3D_BAG_GEW_ES21	ATMN270B
AOA150-Bw	PA	USA	LU.S040B.110	AOA150-Bw AOXPHESTUS1 MC UMACw 2*512/120/3L/5R/CB_bg_0.3D_BAG_GEW_EN31	ATMN270B
AOA150-Aw	PA	ACLA-Spanish	LU.S040A.111	AOA150-Aw AOLINXSEA1 UMACw 2*512/120/3L/5R/CB_bg_0.3D_BAG_GEW_ES21	ATMN270B
AOA150-Bw	PA	ACLA-Portuguese	LU.S040B.004	AOA150-Bw AOXPHESTXC1 MC UMACw 2*512/120/6L/5R/CB_bg_0.3D_BAG_GEW_XC21	ATMN270B
AOA150-Bw	PA	Canada	LU.S040B.002	AOA150-Bw AOXPHESTCA2 MC UMACw 2*512/120/6L/5R/CB_bg_0.3D_BAG_GEW_FR31	ATMN270B
AOA150-Bw	PA	Canada	LU.S040B.109	AOA150-Bw AOXPHESTCA2 MC UMACw 2*512/120/3L/5R/CB_bg_0.3D_BAG_GEW_FR31	ATMN270B
AOA150-Bw	PA	ACLA-Spanish	LU.S040B.003	AOA150-Bw AOXPHESTEA1 MC UMACw 2*512/120/6L/5R/CB_bg_0.3D_BAG_GEW_ES21	ATMN270B
AOA150-Bw	PA	ACLA-Portuguese	LU.S040B.116	AOA150-Bw AOXPHESTXC2 MC UMACw 2*512/120/3L/5R/CB_bg_0.3D_BAG_GEW_XC21	ATMN270B
AOA150-Bw	PA	ACLA-Portuguese	LU.S040B.113	AOA150-Bw AOXPHESTXC2 MC UMACw 512+1G/120/3L/5R/CB_bg_0.3D_BAG_GEW_XC21	ATMN270B

Model	LCD	Memory 1	Memory 2	HDD 1 (GB)	Card Reader	Wireless LAN
AOA150-Bb	NLED8.9WSVGAG	CM512MB(1Gbx4)	SO512MBII6	N80GB5.4KS	5 in 1-Build in	3rd WiFi BG
AOA150-Ab	NLED8.9WSVGAG	CM512MB(1Gbx4)	SO512MBII6	N80GB5.4KS	5 in 1-Build in	3rd WiFi BG
AOA150-Ab	NLED8.9WSVGAG	CM512MB(1Gbx4)	SO512MBII6	N80GB5.4KS	5 in 1-Build in	3rd WiFi BG
AOA150-Ab	NLED8.9WSVGAG	CM512MB(1Gbx4)	SO512MBII6	N80GB5.4KS	5 in 1-Build in	3rd WiFi BG
AOA150-Ab	NLED8.9WSVGAG	CM512MB(1Gbx4)	SO512MBII6	N80GB5.4KS	5 in 1-Build in	3rd WiFi BG
AOA150-Ab	NLED8.9WSVGAG	CM512MB(1Gbx4)	SO512MBII6	N80GB5.4KS	5 in 1-Build in	3rd WiFi BG
AOA150-Ab	NLED8.9WSVGAG	CM512MB(1Gbx4)	SO512MBII6	N80GB5.4KS	5 in 1-Build in	3rd WiFi BG

Model	LCD	Memory 1	Memory 2	HDD 1 (GB)	Card Reader	Wireless LAN
AOA150-Bb	NLED8.9WSVGAG	CM512MB(1Gbx4)	SO512MBII6	N120GB5.4KS	5 in 1-Build in	3rd WiFi BG
AOA150-Bb	NLED8.9WSVGAG	CM512MB(1Gbx4)	N	N120GB5.4KS	5 in 1-Build in	3rd WiFi BG
AOA150-Bb	NLED8.9WSVGAG	CM512MB(1Gbx4)	SO512MBII6	N120GB5.4KS	5 in 1-Build in	3rd WiFi BG
AOA150-Bb	NLED8.9WSVGAG	CM512MB(1Gbx4)	SO512MBII6	N120GB5.4KS	5 in 1-Build in	3rd WiFi BG
AOA150-Bb	NLED8.9WSVGAG	CM512MB(1Gbx4)	SO1GBII6	N120GB5.4KS	5 in 1-Build in	3rd WiFi BG
AOA150-Bb	NLED8.9WSVGAG	CM512MB(1Gbx4)	SO1GBII6	N120GB5.4KS	5 in 1-Build in	3rd WiFi BG
AOA150-Bb	NLED8.9WSVGAG	CM512MB(1Gbx4)	SO512MBII6	N120GB5.4KS	5 in 1-Build in	3rd WiFi BG
AOA150-Bb	NLED8.9WSVGAG	CM512MB(1Gbx4)	SO1GBII6	N120GB5.4KS	5 in 1-Build in	3rd WiFi BG
AOA150-Bb	NLED8.9WSVGAG	CM512MB(1Gbx4)	SO512MBII6	N120GB5.4KS	5 in 1-Build in	3rd WiFi BG
AOA150-Bb	NLED8.9WSVGAG	CM512MB(1Gbx4)	SO512MBII6	N120GB5.4KS	5 in 1-Build in	3rd WiFi BG
AOA150-Bb	NLED8.9WSVGAG	CM512MB(1Gbx4)	SO1GBII6	N120GB5.4KS	5 in 1-Build in	3rd WiFi BG
AOA150-Bb	NLED8.9WSVGAG	CM512MB(1Gbx4)	SO1GBII6	N120GB5.4KS	5 in 1-Build in	3rd WiFi BG
AOA150-Bb	NLED8.9WSVGAG	CM512MB(1Gbx4)	SO512MBII6	N120GB5.4KS	5 in 1-Build in	3rd WiFi BG
AOA150-Bb	NLED8.9WSVGAG	CM512MB(1Gbx4)	N	N120GB5.4KS	5 in 1-Build in	3rd WiFi BG
AOA150-Bb	NLED8.9WSVGAG	CM512MB(1Gbx4)	SO1GBII6	N120GB5.4KS	5 in 1-Build in	3rd WiFi BG
AOA150-Ab	NLED8.9WSVGAG	CM512MB(1Gbx4)	N	N120GB5.4KS	5 in 1-Build in	3rd WiFi BG
AOA150-Bb	NLED8.9WSVGAG	CM512MB(1Gbx4)	SO1GBII6	N120GB5.4KS	5 in 1-Build in	3rd WiFi BG
AOA150-Bb	NLED8.9WSVGAG	CM512MB(1Gbx4)	SO1GBII6	N120GB5.4KS	5 in 1-Build in	3rd WiFi BG
AOA150-Ab	NLED8.9WSVGAG	CM512MB(1Gbx4)	SO512MBII6	N120GB5.4KS	5 in 1-Build in	3rd WiFi BG
AOA150-Ab	NLED8.9WSVGAG	CM512MB(1Gbx4)	SO512MBII6	N120GB5.4KS	5 in 1-Build in	3rd WiFi BG
AOA150-Bb	NLED8.9WSVGAG	CM512MB(1Gbx4)	SO512MBII6	N120GB5.4KS	5 in 1-Build in	3rd WiFi BG
AOA150-Bb	NLED8.9WSVGAG	CM512MB(1Gbx4)	SO1GBII6	N120GB5.4KS	5 in 1-Build in	3rd WiFi BG
AOA150-Ab	NLED8.9WSVGAG	CM512MB(1Gbx4)	SO512MBII6	N120GB5.4KS	5 in 1-Build in	3rd WiFi BG
AOA150-Ab	NLED8.9WSVGAG	CM512MB(1Gbx4)	SO512MBII6	N120GB5.4KS	5 in 1-Build in	3rd WiFi BG
AOA150-Ab	NLED8.9WSVGAG	CM512MB(1Gbx4)	SO512MBII6	N120GB5.4KS	5 in 1-Build in	3rd WiFi BG
AOA150-Ab	NLED8.9WSVGAG	CM512MB(1Gbx4)	SO512MBII6	N120GB5.4KS	5 in 1-Build in	3rd WiFi BG
AOA150-Ab	NLED8.9WSVGAG	CM512MB(1Gbx4)	SO512MBII6	N120GB5.4KS	5 in 1-Build in	3rd WiFi BG
AOA150-Ab	NLED8.9WSVGAG	CM512MB(1Gbx4)	SO512MBII6	N120GB5.4KS	5 in 1-Build in	3rd WiFi BG
AOA150-Ab	NLED8.9WSVGAG	CM512MB(1Gbx4)	SO512MBII6	N120GB5.4KS	5 in 1-Build in	3rd WiFi BG
AOA150-Ab	NLED8.9WSVGAG	CM512MB(1Gbx4)	SO1GBII6	N120GB5.4KS	5 in 1-Build in	3rd WiFi BG

Test Compatible Components

This computer's compatibility is tested and verified by Acer's internal testing department. All of its system functions are tested under Windows® XP Home, Windows® XP Pro environment.

Refer to the following lists for components, adapter cards, and peripherals which have passed these tests. Regarding configuration, combination and test procedures, please refer to the Aspire one series Compatibility Test Report released by the Acer Mobile System Testing Department.

Linux Environment Test

Aspire one Blue Testing Information

Vendor	Type	Description
2nd Battery Test		
60001535 PANASONIC	6CELL2.6	Battery PANASONIC UM-2008B Li-Ion 3S2P PANASONIC 6 cell 5200mAh Main COMMON Macles Black
60002162 SIMPLO	6CELL2.6	Battery SIMPLO UM-2008B Li-Ion 3S2P PANASONIC 6 cell 5200mAh Main COMMON Macles Black
60002162 SIMPLO	6CELL2.6	Battery SIMPLO UM-2008B Li-Ion 3S2P SAMSUNG 6 cell 5200mAh Main COMMON Macles Black
Cover Test		
9999995 ONE TIME VENDER	Blue IMR	Blue IMR
Accessory Test		
10001028 QUANTA	Macles Bag Black	Macles Bag Black
Adapter Test		
10001081 DELTA	30W	Adapter DELTA 30W 19V 1.7x5.5x11 Black ADP-30JH BA LF
60003544 LITE-ON OPT	30W	Adapter LITE-ON 30W 1.7x5.5x11 Black PA-1300-04AC LF
60002015 HIPRO	30W	Adapter HIPRO 30W 19V 1.7x5.5x11 Black HP-A0301R3 B1LF LF
Audio Codec Test		
9999995 ONE TIME VENDER	ALC268	ALC268
B Cover Test		
9999995 ONE TIME VENDER	Mirror w/Camera	Mirror w/Camera
Battery Test		
60001921 SANYO	3CELL2.2	Battery SANYO UM-2008A Li-Ion 3S1P SANYO 3 cell 4400mAh Main COMMON Macles
60001535 PANASONIC	3CELL2.2	Battery PANASONIC UM-2008A Li-Ion 3S1P PANASONIC 3 cell 4400mAh Main COMMON Macles
60004764 CELXPER	3CELL2.2	Battery SAMSUNG UM-2008A Li-Ion 3S1P SAMSUNG 3 cell 2200mAh Main COMMON Black, Macles
60002162 SIMPLO	3CELL2.2	Battery SIMPLO UM-2008A Li-Ion 3S1P PANASONIC 3 cell 4400mAh Main COMMON Macles
60002162 SIMPLO	3CELL2.2	Battery SIMPLO UM-2008A Li-Ion 3S1P SAMSUNG 3 cell 4400mAh Main COMMON Macles
60001535 PANASONIC	6CELL2.6	Battery PANASONIC UM-2008B Li-Ion 3S2P PANASONIC 6 cell 5200mAh Main COMMON Macles Black
60002162 SIMPLO	6CELL2.6	Battery SIMPLO UM-2008B Li-Ion 3S2P PANASONIC 6 cell 5200mAh Main COMMON Macles Black
60002162 SIMPLO	6CELL2.6	Battery SIMPLO UM-2008B Li-Ion 3S2P SAMSUNG 6 cell 5200mAh Main COMMON Macles Black

Vendor	Type	Description
CPU Test		
10001067 INTEL	ATMN270B	CPU Intel Atom N270 1.6G 512K 533 2.5W
Camera Test		
9999995 ONE TIME VENDER	0.3M LDV	Suyin Camera Rosa
9999995 ONE TIME VENDER	0.3M LDV	Liteon Camera Lily
Card Reader Test		
9999995 ONE TIME VENDER	5 in 1-Build in	5 in 1-Build in MS, MS Pro, SD, SC, XD
Card Bus 1 Test		
9999995 ONE TIME VENDER	JMB385	JMicron JMB385 Card Reader: SD/MMC/MS/MS Duo/MS-HG (1/4/8-bit) & xD (PCI Express)
Card Bus 2 Test		
9999995 ONE TIME VENDER	JMB385	JMicron JMB385 Card Reader: SD/MMC/MS/MS Duo/MS-HG (1/4/8-bit) & xD (PCI Express)
HDD Test		
60002036 SEAGATE	N120GB5.4KS	HDD SEAGATE 2.5" 5400rpm 120GB ST9120817AS Corsair SATA LF F/W:3.AAA
60001922 TOSHIBA DIGI	N120GB5.4KS	HDD TOSHIBA 2.5" 5400rpm 120GB MK1252GSX Virgo BS SATA LF F/W:LV010J
60002005 HGST SG	N120GB5.4KS	HDD HGST 2.5" 5400rpm 120GB HTS543212L9A300 Falcon-B SATA LF F/W:C40C
60001994 WD	N120GB5.4KS	HDD WD 2.5" 5400rpm 120GB WD1200BEVS-22UST0 ML125 SATA LF F/W:01.01A01
Keyboard Test		
820123 DARFON	8KB-FV1 Black	Keyboard 8KB-FV1 Black Macles Standard
LAN Test		
9999995 ONE TIME VENDER	RTL8102EL	RTL8102EL
LCD Test		
60003316 AUO	NLED8.9WSVGAG	LED LCD AUO 8.9" WSVGA Glare B089AW01 V1 LF 180nit 30ms
60002215 SAMSUNG	NLED8.9WSVGAG	LED LCD SAMSUNG 8.9" WSVGA Glare LMS890JF01 LF 200nit 16ms 500:1
60003089 LG	NLED8.9WSVGAG	LED LCD LPL 8.9" WSVGA Glare LP089WS1-TLA1 LF 180nit 16ms 500:1
10001038 CMO	NLED8.9WSVGAG	LED LCD CMO 8.9" WSVGA Glare N089L6-L02 LF 180nit 16ms
Memory Test		
10000119 AMT	CM512MB (1Gb x 4)	Memory Chip NONE DDRII 667 512MB chip 64x16 * 4 LF
16081942 MICRON	SO1GBII6	Memory MICRON SO-DIMM DDRII 667 1GB MT8HTF12864HDY-667E1 LF
60002214 ELPIDA	SO1GBII6	Memory ELPIDA SO-DIMM DDRII 667 1GB EBE11UE6ACUA-6E-E LF 64*16 0.065um

Vendor	Type	Description
60002215 SAMSUNG	SO1GBII6	Memory SAMSUNG SO-DIMM DDRII 667 1GB M470T2864QZ3-CE6 LF
60002215 SAMSUNG	SO512MBII6	Memory SAMSUNG SO-DIMM DDRII 667 512MB M470T6554EZ3-CE6 LF 32*16 0.08um
60002215 SAMSUNG	SO512MBII6	Memory SAMSUNG SO-DIMM DDRII 667 512MB M470T6464QZ3-CE6 LF
60002045 HYNIX	SO512MBII6	Memory HYNIX SO-DIMM DDRII 667 512MB HYMP164S64CP6-Y5 LF 64*16 0.065um
NB Chipset Test		
10001067 INTEL	945GSE	NB Chipset Intel CS QG82945GSE MM#897840
SB Chipset Test		
10001067 INTEL	ICH7M	ICH7M
Software Test		
10000981 MISC	McAfee	Antivirus application McAfee
VGA Test		
9999995 ONE TIME VENDER	UMA	UMA
WiFi Antenna Test		
9999995 ONE TIME VENDER	PIFA	PIFA
Wireless LAN Test		
23707801 FOXCONN TW	3rd WiFi BG	Foxconn FOX_ATH_XB63 Foxconn Atheros XB63 minicard b/g

Aspire one White Testing Information

Vendor	Type	Description
2nd Battery Test		
60001535 PANASONIC	6CELL2.6	Battery PANASONIC UM-2008B Li-Ion 3S2P PANASONIC 6 cell 5200mAh Main COMMON Macles Black
Cover Test		
9999995 ONE TIME VENDER	White IMR	White IMR
Accessory Test		
10001028 QUANTA	Macles Bag Black	Macles Bag Black
Adapter Test		
10001081 DELTA	30W	Adapter DELTA 30W 19V 1.7x5.5x11 Black ADP-30JH BA LF
60003544 LITE-ON OPT	30W	Adapter LITE-ON 30W 1.7x5.5x11 Black PA-1300-04AC LF
60002015 HIPRO	30W	Adapter HIPRO 30W 19V 1.7x5.5x11 Black HP-A0301R3 B1LF LF

Vendor	Type	Description
Audio Codec Test		
9999995 ONE TIME VENDER	ALC268	ALC268
B Cover Test		
9999995 ONE TIME VENDER	Mirror w/Camera	Mirror w/Camera
Battery Test		
60001921 SANYO	3CELL2.2	Battery SANYO UM-2008A Li-Ion 3S1P SANYO 3 cell 4400mAh Main COMMON Macles
60001535 PANASONIC	3CELL2.2	Battery PANASONIC UM-2008A Li-Ion 3S1P PANASONIC 3 cell 4400mAh Main COMMON Macles
60002162 SIMPLO	3CELL2.2	Battery SIMPLO UM-2008A Li-Ion 3S1P PANASONIC 3 cell 4400mAh Main COMMON Macles
60002162 SIMPLO	3CELL2.2	Battery SIMPLO UM-2008A Li-Ion 3S1P SAMSUNG 3 cell 4400mAh Main COMMON Macles
60001535 PANASONIC	6CELL2.6	Battery PANASONIC UM-2008B Li-Ion 3S2P PANASONIC 6 cell 5200mAh Main COMMON Macles Black
60002162 SIMPLO	6CELL2.6	Battery SIMPLO UM-2008B Li-Ion 3S2P PANASONIC 6 cell 5200mAh Main COMMON Macles Black
60002162 SIMPLO	6CELL2.6	Battery SIMPLO UM-2008B Li-Ion 3S2P SAMSUNG 6 cell 5200mAh Main COMMON Macles Black
CPU Test		
10001067 INTEL	ATMN270B	CPU Intel Atom N270 1.6G 512K 533 2.5W
Camera Test		
9999995 ONE TIME VENDER	0.3M LDV	Suyin Camera Rosa
9999995 ONE TIME VENDER	0.3M LDV	Liteon Camera Lily
Card Reader Test		
9999995 ONE TIME VENDER	5 in 1-Build in	5 in 1-Build in MS, MS Pro, SD, SC, XD
Card Bus 1 Test		
9999995 ONE TIME VENDER	JMB385	JMicron JMB385 Card Reader: SD/MMC/MS/MS Duo/MS-HG (1/4/8-bit) & xD (PCI Express)
Card Bus 2 Test		
9999995 ONE TIME VENDER	JMB385	JMicron JMB385 Card Reader: SD/MMC/MS/MS Duo/MS-HG (1/4/8-bit) & xD (PCI Express)
HDD Test		
60002036 SEAGATE	N120GB5.4KS	HDD SEAGATE 2.5" 5400rpm 120GB ST9120817AS Corsair SATA LF F/W:3.AAA
60001922 TOSHIBA DIGI	N120GB5.4KS	HDD TOSHIBA 2.5" 5400rpm 120GB MK1252GSX Virgo BS SATA LF F/W:LV010J
60002005 HGST SG	N120GB5.4KS	HDD HGST 2.5" 5400rpm 120GB HTS543212L9A300 Falcon-B SATA LF F/W:C40C
60001994 WD	N120GB5.4KS	HDD WD 2.5" 5400rpm 120GB WD1200BEVS-22UST0 ML125 SATA LF F/W:01.01A01
60001994 WD	N120GB5.4KS	HDD WD 2.5" 5400rpm 120GB WD1200BEVT-22ZCT0 ML160 SATA LF F/W: 11.01A11

Vendor	Type	Description
Keyboard Test		
820123 DARFON	8KB-FV2 White	Keyboard 8KB-FV2 White Macles Internal Standard White
LAN Test		
9999995 ONE TIME VENDER	RTL8102EL	RTL8102EL
LCD Test		
60003316 AUO	NLED8.9WSVGAG	LED LCD AUO 8.9" WSVGA Glare B089AW01 V1 LF 180nit 30ms
60002215 SAMSUNG	NLED8.9WSVGAG	LED LCD SAMSUNG 8.9" WSVGA Glare LMS890JF01 LF 200nit 16ms 500:1
60003089 LG	NLED8.9WSVGAG	LED LCD LPL 8.9" WSVGA Glare LP089WS1-TLA1 LF 180nit 16ms 500:1
10001038 CMO	NLED8.9WSVGAG	LED LCD CMO 8.9" WSVGA Glare N089L6-L02 LF 180nit 16ms
Memory Test		
10000119 AMT	CM512MB (1Gb x 4)	Memory Chip NONE DDRII 667 512MB chip 64x16 * 4 LF
16081942 MICRON	SO1GBII6	Memory MICRON SO-DIMM DDRII 667 1GB MT8HTF12864HDY-667E1 LF
60002214 ELPIDA	SO1GBII6	Memory ELPIDA SO-DIMM DDRII 667 1GB EBE11UE6ACUA-6E-E LF 64*16 0.065um
60002215 SAMSUNG	SO1GBII6	Memory SAMSUNG SO-DIMM DDRII 667 1GB M470T2864QZ3-CE6 LF
60002215 SAMSUNG	SO512MBII6	Memory SAMSUNG SO-DIMM DDRII 667 512MB M470T6554EZ3-CE6 LF 32*16 0.08um
60002215 SAMSUNG	SO512MBII6	Memory SAMSUNG SO-DIMM DDRII 667 512MB M470T6464QZ3-CE6 LF
60002045 HYNIX	SO512MBII6	Memory HYNIX SO-DIMM DDRII 667 512MB HYMP164S64CP6-Y5 LF 64*16 0.065um
NB Chipset Test		
10001067 INTEL	945GSE	NB Chipset Intel CS QG82945GSE MM#897840
SB Chipset Test		
10001067 INTEL	ICH7M	ICH7M
Software Test		
10000981 MISC	McAfee	Antivirus application McAfee
VGA Test		
9999995 ONE TIME VENDER	UMA	UMA
WiFi Antenna Test		
9999995 ONE TIME VENDER	PIFA	PIFA
Wireless LAN Test		
23707801 FOXCONN TW	3rd WiFi BG	Foxconn FOX_ATH_XB63 Foxconn Atheros XB63 minicard b/g

Online Support Information

This section describes online technical support services available to help you repair your Acer Systems.

If you are a distributor, dealer, ASP or TPM, please refer your technical queries to your local Acer branch office. Acer Branch Offices and Regional Business Units may access our website. However some information sources will require a user i.d. and password. These can be obtained directly from Acer CSD Taiwan.

Acer's Website offers you convenient and valuable support resources whenever you need them.

In the Technical Information section you can download information on all of Acer's Notebook, Desktop and Server models including:

- Service guides for all models
- User's manuals
- Training materials
- Bios updates
- Software utilities
- Spare parts lists
- TABs (Technical Announcement Bulletin)

For these purposes, we have included an Acrobat File to facilitate the problem-free downloading of our technical material.

Also contained on this website are:

- Detailed information on Acer's International Traveler's Warranty (ITW)
- Returned material authorization procedures
- An overview of all the support services we offer, accompanied by a list of telephone, fax and email contacts for all your technical queries.

We are always looking for ways to optimize and improve our services, so if you have any suggestions or comments, please do not hesitate to communicate these to us.

Numerics

3G cover 37

A

AFLASH Utility 27

B

Battery Pack 36

BIOS

- package 14
- ROM size 14
- ROM type 14
- vendor 14
- Version 14

BIOS Utility 19–27

- Advanced 22
- Boot 25
- Exit 26
- Navigating 19
- Onboard Device Configuration 23
- Save and Exit 26
- Security 22
- System Security 26

Board Layout

- Top View 111

brightness

- hotkeys 10

C

Camera Module 45, 46

caps lock

- on indicator 7

Common Problems 80

D

DIMM Module 60

Display 3

display

- hotkeys 10

E

Euro 11

External Module Disassembly

Flowchart 35

F

Features 1

Flash Utility 27

FPC Cable 48

FRU (Field Replaceable Unit) List 115

H

Hard Disk Drive Module 53, 58

Hibernation mode

- hotkey 10

Hot Keys 9

I

Indicators 7

Intermittent Problems 91

Internal Microphone Failure 87

Internal Speaker Failure 85

J

Jumper and Connector Locations 111

- Top View 111

K

Keyboard 38

Keyboard Failure 84

L

LCD Bezel 44

LCD Brackets 48

LCD Failure 84

LCD Module Disassembly

- Flowchart 41

LCD Panel 47

Linux Environment Test 156

M

Main Unit Disassembly

- Flowchart 50

Mainboard 55
media access
 on indicator 7
Memory Check 80
Model Definition 128

N

No Display Issue 81
num lock
 on indicator 7

O

ODD Failure 89
Online Support Information 161

P

Panel 4
 Bottom 7
 left 4
PC Card 7
POST Codes
 Reference Tables 102
Power Button Failure 89
Power On Failure 80

S

Speaker Module 56
speakers
 hotkey 10
System
 Block Diagram 3

T

Test Compatible Components 155
Top 111
Touch Pad
 hotkey 10
Touch Pad Failure 85
Troubleshooting
 Built-in KB Failure 84
 Internal Microphone 87
 Internal Speakers 85
 LCD Failure 84
 No Display 81

ODD 89
Other Failures 90
Power Button 89
Power On 80
Touch Pad 85
USB 89
WLAN 90

U

Undetermined Problems 91
upper and lower covers 39
USB Failure (Rightside) 89
utility
 BIOS 19–27

V

volume
 hotkeys 10

W

Windows 2000 Environment Test 156
Wireless Function Failure 90
WLAN Board 50